



Electronic Funds Transfer/E-File (XML) Sales, Use, Accommodations, and Local Taxes

Implementation Guide for Software Development

Contents

Requirements.....	1
Overview	1
Flow of data	1
Software developers	2
Testing Procedures.....	2
Technical Specifications.....	3
Introduction	3
Schema set overview	3
TransmissionHeader.....	4
ReturnHeader and ReturnData	6
FinancialTransaction.....	17
Additional Software Edits	19
Acknowledgement Overview	21

Requirements

South Carolina uses the XML format and follows standards developed under the sponsorship of the Federation of Tax Administrators.

You must visit dor.sc.gov/software-developers/Pages/home.aspx to obtain the XML Schema set, as well as an XPath document giving more details on how to map the South Carolina Sales and Use Tax forms and sample XML submissions.

The SCDOR's VAN is BSWA.

Contact BSWA for E-File (XML) or file receipt questions at BSWA_ALL@BSWA.net or 1-281-342-2646.

Overview

As of March 2016, the South Carolina Department of Revenue (SCDOR) utilizes the Federation of Tax Administrators (FTA) E-File in eXtensible Mark-up Language (XML) for filing of Full Sales and Use Tax.

The schema set defining the XML format change can be found at dor.sc.gov/software-developers/Pages/home.aspx

Flow of data

All parties intending to transmit to the SCDOR must verify that they, their VAN, or their service bureau is able to interconnect with the SCDOR's VAN, which is BSWA.

Taxpayers will transmit the XML document to BSWA. If using the ACH debit payment method, the taxpayer will include in the XML document banking information necessary to initiate the transaction. BSWA will build an ACH record and transmit the record to the State's bank, who will originate the transaction. BSWA will translate the XML into a predefined record and transmit it to the State.

If the taxpayer is using the credit payment method, they will directly instruct their bank to initiate their credit, and will code the XML document to indicate the use of ACH credit. BSWA will then translate the XML into the predefined record and transmit it to the State.

Your place in the process is one of the most crucial. The SCDOR depends on you to develop software that will meet the SCDOR's layout and edit requirements. The users of the software count on you to develop a user-friendly package that will fit their business needs and ensure accurate translation of their data.

To assist you, the remainder of this handbook provides contacts if you have questions or need additional information, an overview of the XML schema set, special edits to follow, and testing procedures that we require you to use. Additionally, an XPath document to assist in mapping the South Carolina forms to the XML and sample XML return documents can be found at dor.sc.gov/software-developers/Pages/home.aspx

Please note: When there is a version change to your software, the SCDOR requires you to test your software changes with us prior to release to your taxpayers. To provide the best service to our taxpayers and your clients, please keep the SCDOR informed of your actual release date.

Testing Procedures

A test package for software developers can be found at dor.sc.gov/software-developers/Pages/home.aspx. **All developers must register with the SCDOR and test prior to the use of their software for live transmission by taxpayers to South Carolina.**

Complete the [D-138, Registration Application](#) prior to setting up your communication link with BSWA. Email your application to XML@dor.sc.gov. After receiving your application, the SCDOR will contact BSWA to have your mailboxes set up.

Contact the SCDOR when you are ready to test with us. The test package includes numerous examples common to taxpayers of South Carolina. If your software will not offer all aspects of Sales Tax filing (for example, you may not wish to include Accommodations Tax), inform us in the initial contact, and you will not need to test that example.

When you send a file to BSWA for processing, be sure that you receive your email acknowledgment to be certain your test has passed the initial edits. If you have a problem with any aspect of your transmission, contact BSWA at BSWA_ALL@BSWA.net or **1-281-342-2646**.

The files are pulled each business day, translated, and sent to the SCDOR for review. Your acknowledgment (second email) will be available within 48 hours after the date of transmission.

After receiving your test, we will notify you of the results. Continued testing is often required. After you have successfully completed the testing process, you will be notified that you can make your software available to taxpayers. You will also be notified of your software ID production code by email.

When you make a significant change to your software package, you must run another test with the SCDOR to ensure accuracy and reliability for your users.

Technical Specifications

Introduction

XML is often described as a “self-defining” language. This is because rather than data fields being separated by special characters, each field is sandwiched between “tags” which give the identity of the tag; for example, <GrossSales>46623</GrossSales>.

The specifications for the SCDOR Sales XML program are called a “schema set.” A schema is an XML document that describes the content and formatting of another XML document. A schema set is a collection of related schemas used together to create a complete XML document specification. The schema set used for the SCDOR Sales XML program is customized from a national specification developed by the technical standards working group of the Federation of Tax Administrators.

Schema set overview

The diagram below shows an overview of the complete schema set for an XML transmission. Each box represents a separate schema in the schema set. The “Transmission” schemas link all the parts together.

All diagrams in this book use the following indicators:

- Required element- solid line
- Optional element- dotted line
- Comprised of other elements- plus symbol (+) at the end of the item (see TransmissionHeader below)
- Repeatable element- number below the element (see ReturnState below)
- Unlimited repetitions allowed- infinity symbol (∞) (see ReturnState below)

If the descriptions below state that an element is not used, then it must be omitted from the XML return.

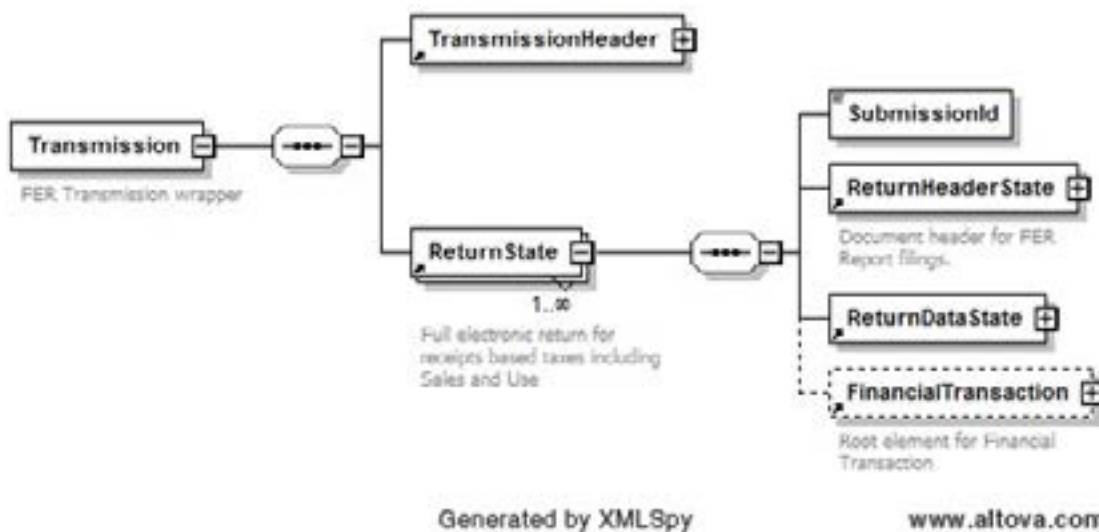

The **TransmissionHeader** identifies the Transmitter by:

1. Giving the primary taxpayer identification for the entire transmission, including all separate retail returns,
2. Assigning a unique identifying number to the particular transmission,
3. Indicating “test” or “production” status, and
4. Including a return count for the transmission.

The **ReturnState** schema is the actual return, which can occur multiple times in the transmission, and is made up of four elements.

1. The SubmissionId data field is a unique identifying number assigned to each return in the transmission by the software creating the return.
2. The ReturnHeaderState schema contains “top of the form” information such as the filing jurisdiction (South Carolina), period covered, return preparer (if not the taxpayer), and identifying data for the taxpayer.
3. The ReturnDataState schema contains the actual Sales Tax form data.
4. The FinancialTransaction schema contains the data fields necessary for either an ACH debit or credit payment.

All of these schemas will be discussed in more detail in the following sections.

NOTE: There are actually two different forms of Transactions in this schema set, each with its own ReturnState and ReturnDataState. One is for the form ST-3 and an optional form ST-389; and one is for the form ST-388 with the required form ST-3T and an optional form ST-389. All three Transmission, ReturnState, and ReturnDataState schemas each have the same root element names, but different file (.xsd) names.

TransmissionHeader

- The top attribute is required and contains the number of returns in the transmission.
- The Jurisdiction is the state to which the return is being sent; for the SCDOR it is “SC”.
- The TransmissionId is a number assigned by the transmission software that uniquely identifies the transmission; if you have participated in the SCDOR’s Sales EDI program, it is the same number as the ISA13.
- The timestamp is the date and time of the transmission.
- Transmitter is the primary taxpayer identification, regardless of the number of separate retail location returns in the transmission. You **MUST** place the taxpayer’s state-assigned registration number, referred to as the SID, in the StateEIN element. This is the same value as the EDI BT110 field.
- ProcessType is “T” for test or “P” for a production transmission.
- AgentIdentifier, ReportingAgentSignature, and AckAddress are not used in this program.

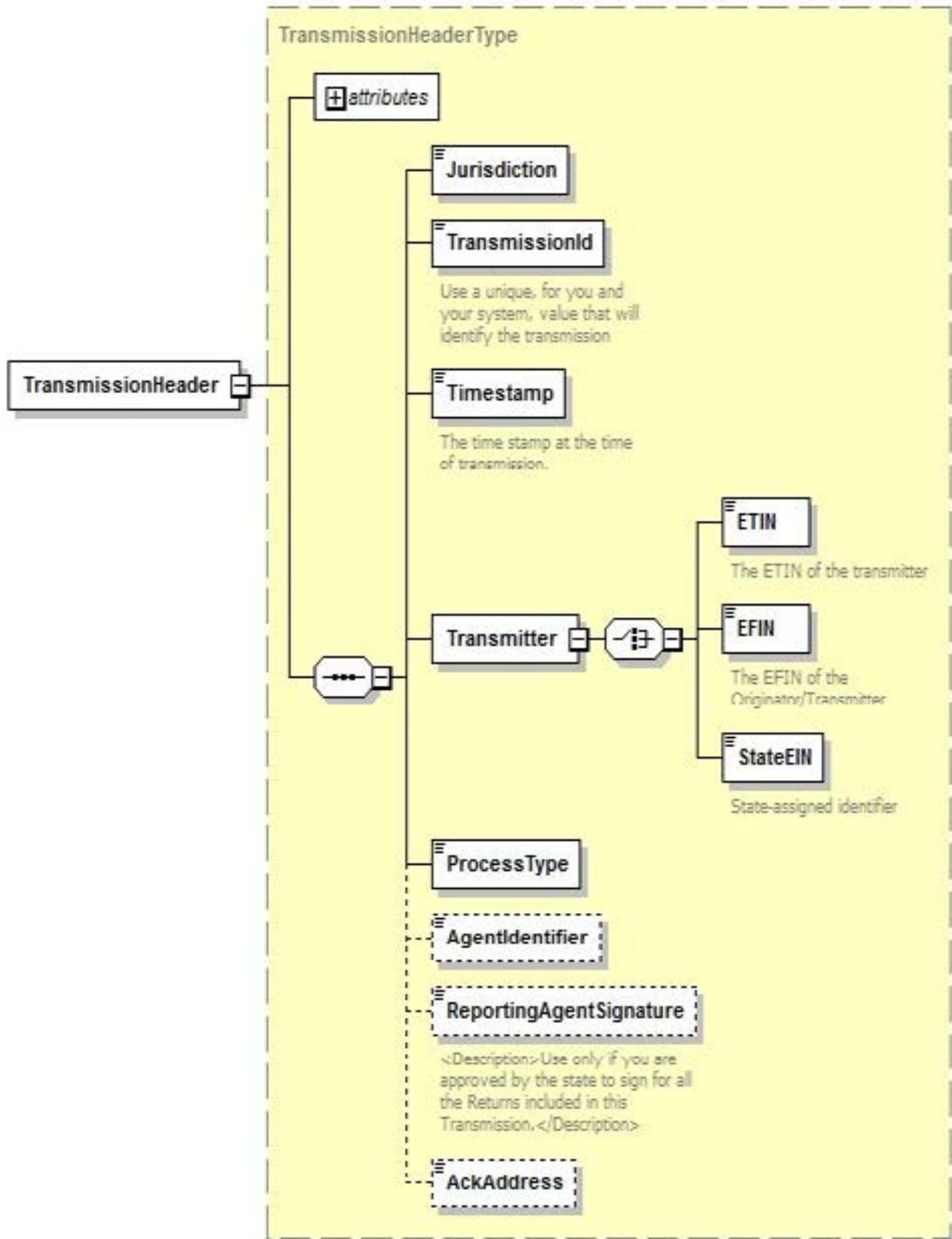

Generated by XMLSpy

www.altova.com

ReturnHeader and ReturnData

FERReturnHeaderState

The **ReturnHeaderState** is the schema which gives basic information about the return filing.

- The top attribute is optional and contains the number of binary attachments in the return filing.
- Jurisdiction is “SC” for a South Carolina return.
- Timestamp is the date and time when the return is created.
- For a monthly filer, TaxPeriodBeginDate and TaxPeriodEndDate give the beginning and end of the tax period; for example “2022-01-01” and “2022-01-31”.
- Tax Year is required for all filers, including annual filers.
- For a quarterly filer, Quarter gives the quarter covered by the return, “1”, “2”, “3”, or “4”.
- If you are requesting relief of due date or amount of tax due to an official state disaster, you will be informed what to put in this element. Otherwise, do not use the element.
- ISPNumber is not used.
- Paid Preparer Information is used if a paid Sales Tax preparer, such as a CPA or a Certified Services Provider, has prepared the return. Please see second diagram for expansion.
 - If the preparer is an independent individual, please provide preparer’s SSN as well as the name of the preparer in the PreparerPersonName element.
 - If the return was prepared by a business, such as a CPA firm, please give the FEIN of the business in the PreparerFirmIDNumber as well as the PreparerBusinessName, and the name of the individual within the firm responsible for the return in the PreparerPersonName element.
 - The address and phone number of the preparer are optional.
- Originator is not used.
- SoftwareID is the identification number provided by the SCDOR to each software provider.
- SoftwareVersion is used for the version/release number of the software.
- For online software, InternetProtocol must contain the IP address of the return creator and the date and time that the return was first transmitted by the creator.
- SignatureOption is not used.
- The SCDOR does not allow amended returns to be filed through this program at this time. For this reason, the three elements AmendedReturnIndicator, OriginalSubmissionId, and OriginalSubmissionDate are not used.
- ReturnType indicates the type of filing. It is an enumerated list in the filing, which means that only the values given in the Return Type element in the FERStateEnumerations schema are acceptable. The value given must match the Transmission, ReturnState, and ReturnDataState type, whether SCST3 or SCST388.
- SubmissionId is a unique value assigned by the sender to the return, equivalent to EDI ST02.
- FilingFrequency must equal “M” for a monthly filer, “Q” for a quarterly filer, or “A” for an annual filer.

- If this is the first return for a new South Carolina filer, put an “X” in the FirstReturnIndicator element and the date of first retail sale in the DateStartedSales element. If it is not the first return, then the FirstReturn element containing these two sub-elements is not used.
- If this is the final return for a taxpayer who has ceased sales, then put an “X” in the LastReturnID indicator element and the date of the final sale in the DateCeasedSales element. If this is not the final return, the LastReturn element containing these two sub-elements is not used.
- If the taxpayer is a seasonal seller, who only makes retail sales for part of the year, put an “X” in the SeasonalIndicator element.
- The Filer element defines the taxpayer for this specific return. It has the following sub-elements:
 - The TIN is the taxpayer’s federal identification number. For a sole proprietor, place “SSN” in TypeTIN and the taxpayer’s SSN in the TINTypeValue element. For a business taxpayer, place “FEIN” in TypeTIN and the taxpayer’s FEIN in the TINTypeValue element.
 - Place the Retail License number of this return in the StateTaxpayerId element. **THE RETURN WILL BE REJECTED WITHOUT THIS DATA!**
 - Place the taxpayer’s name in the BusinessNameLine1 and BusinessName Line2 elements. There is a place for two lines if needed for a “Doing Business As” name.
 - InCareOfName is optional if needed.
 - The address of the taxpayer’s retail license is required, and there is a choice of US format or foreign format. For a US address, place street address (two lines if needed), city, state, and zip code in the appropriate elements.
 - FilerPIN and DateSigned are not used.
- The Contact element includes the required ContactName, plus ContactPhone and ContactEmail. If this is a new contact, place an “X” in the ContactChangeIndicator; otherwise this element is not used.
- The AckAddress element is not used.

Below are different views of the **FERReturnHeaderState**, showing various parts of the schema expanded for viewing.

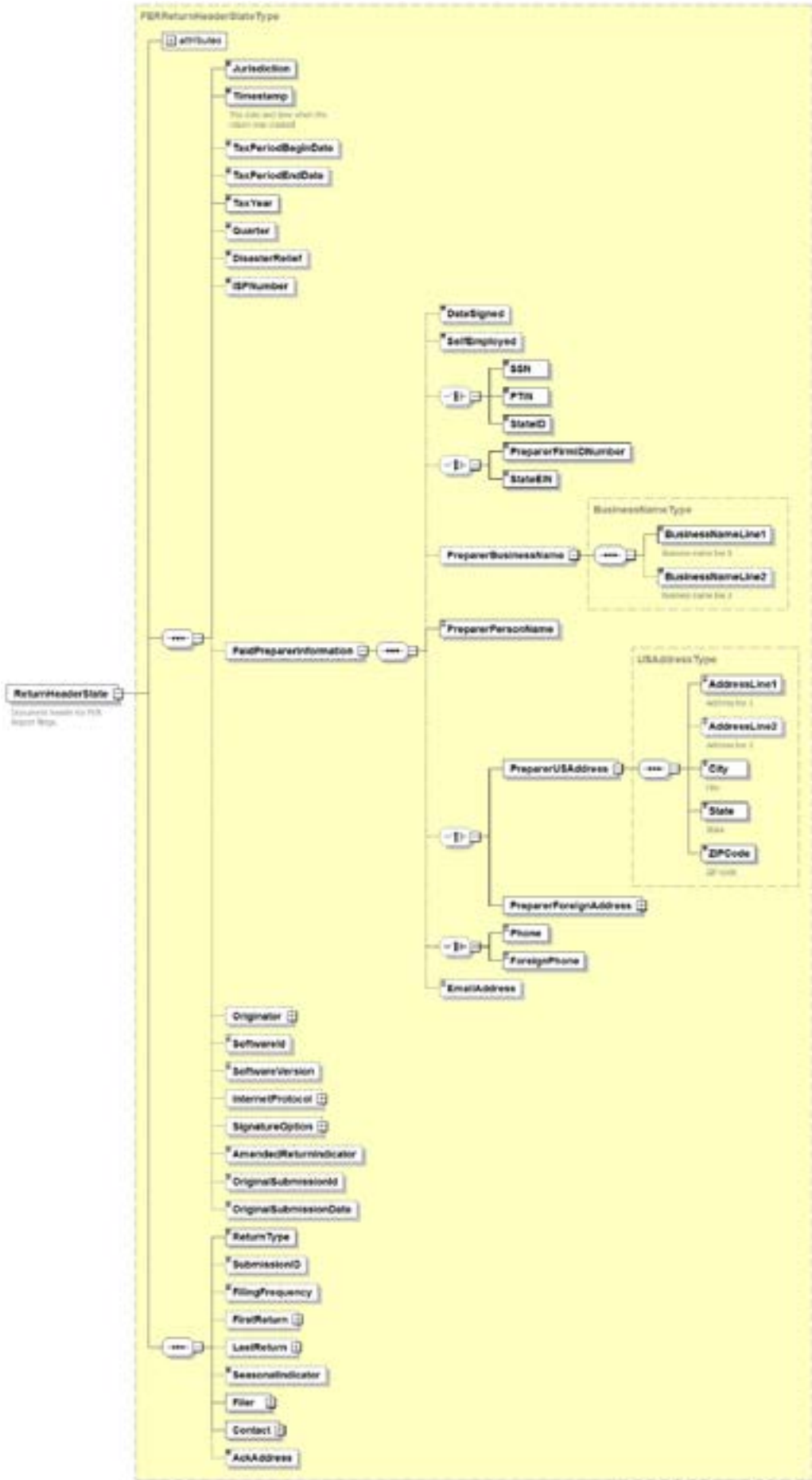

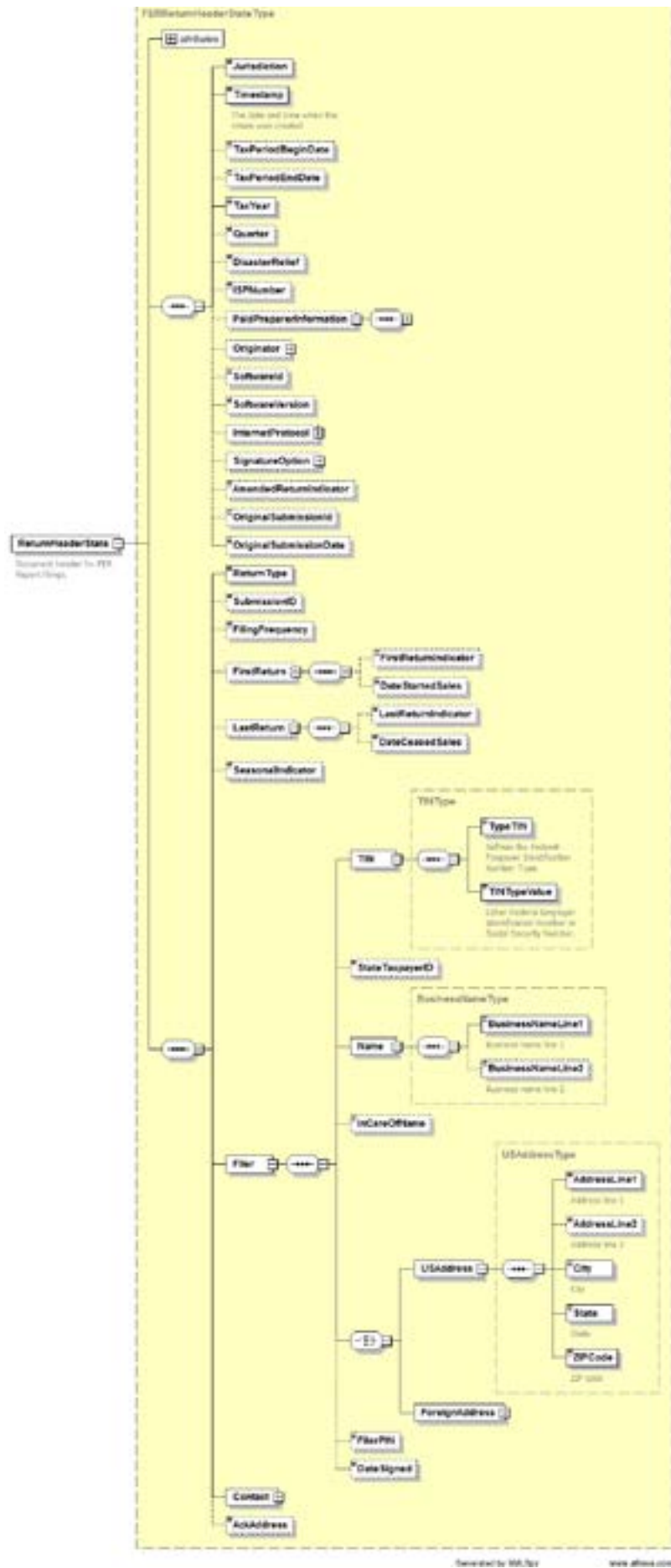

Generated by XMLSpy www.altova.com

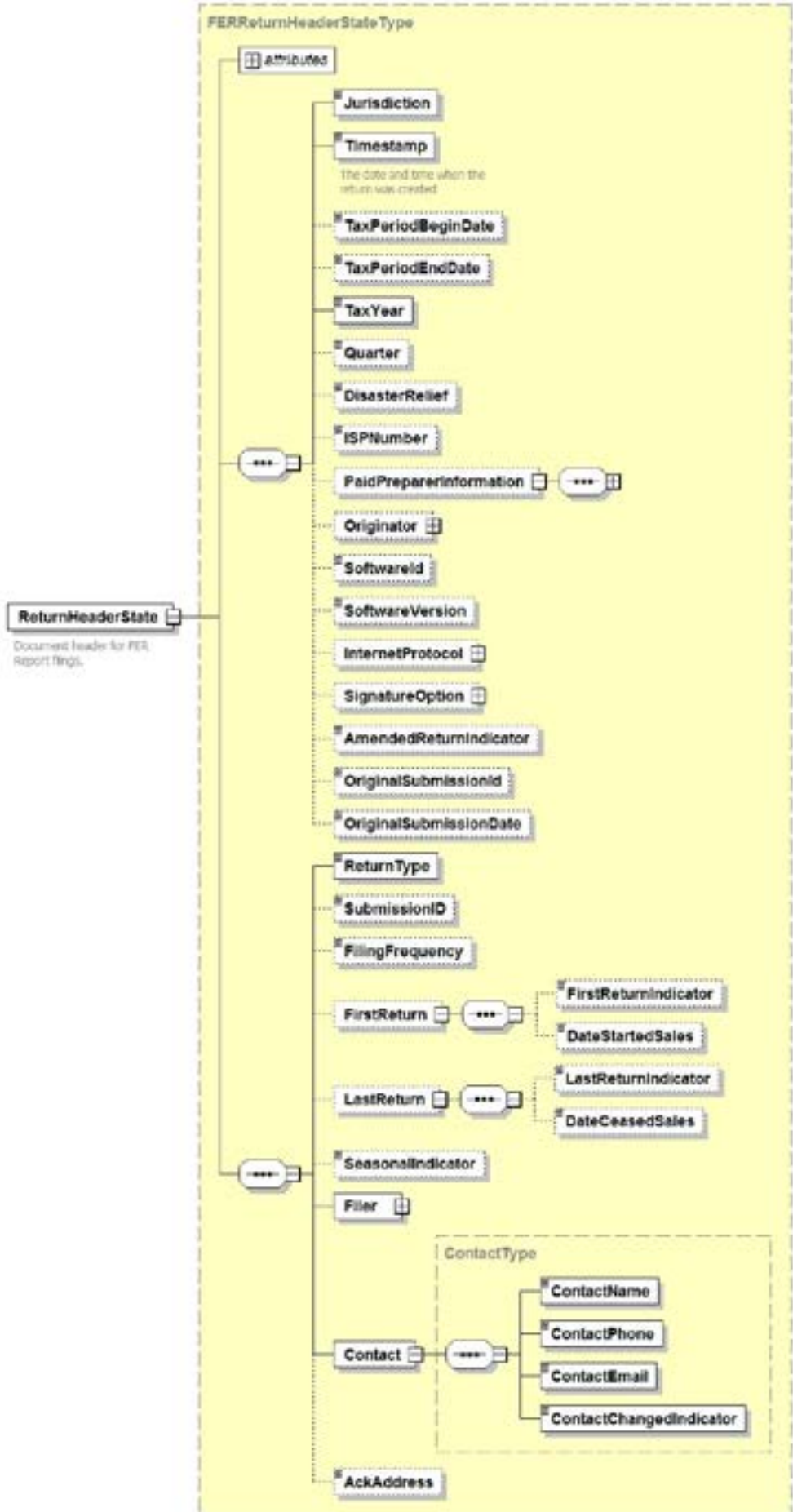

ReturnDataST3 and ReturnDataST388

These schemas contain the line items of the return. ReturnDataST3 contains the SCST3 plus an optional SCST389. ReturnDataST388 contains the SCST388 plus required SCST3T plus an optional SCST389.

For the line item detail mapping between the South Carolina tax forms and the schemas, and various edits and notes, please see the XPath Document located at dor.sc.gov/software-developers/Pages/Home.aspx. Schema diagrams for the return overview and for the SC form schemas are shown below.

Line items must be entered in dollars and cents, including the period between the dollars and cents amounts. Rounding is not allowed. Wherever deductions are taken, the type of deduction must be coded from an enumerated list of potential deductions.

SCST3 Filing

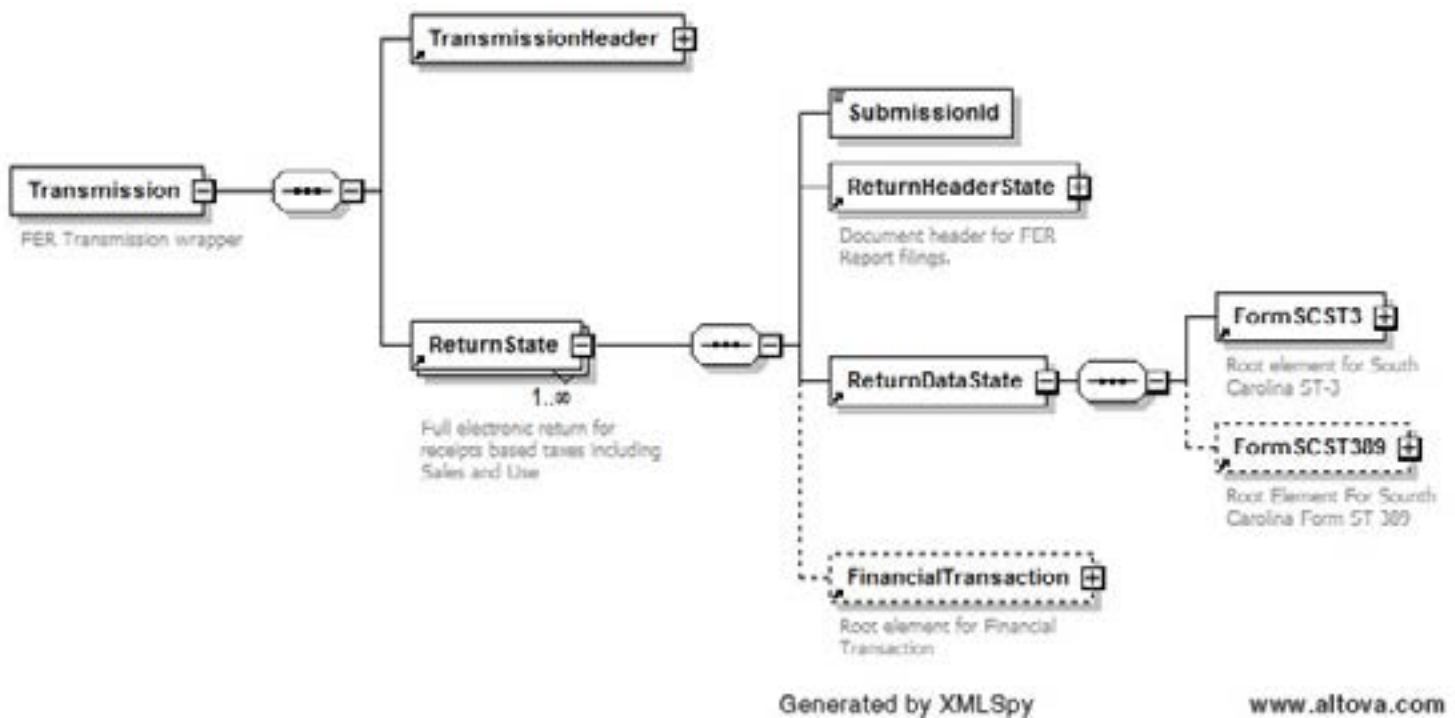

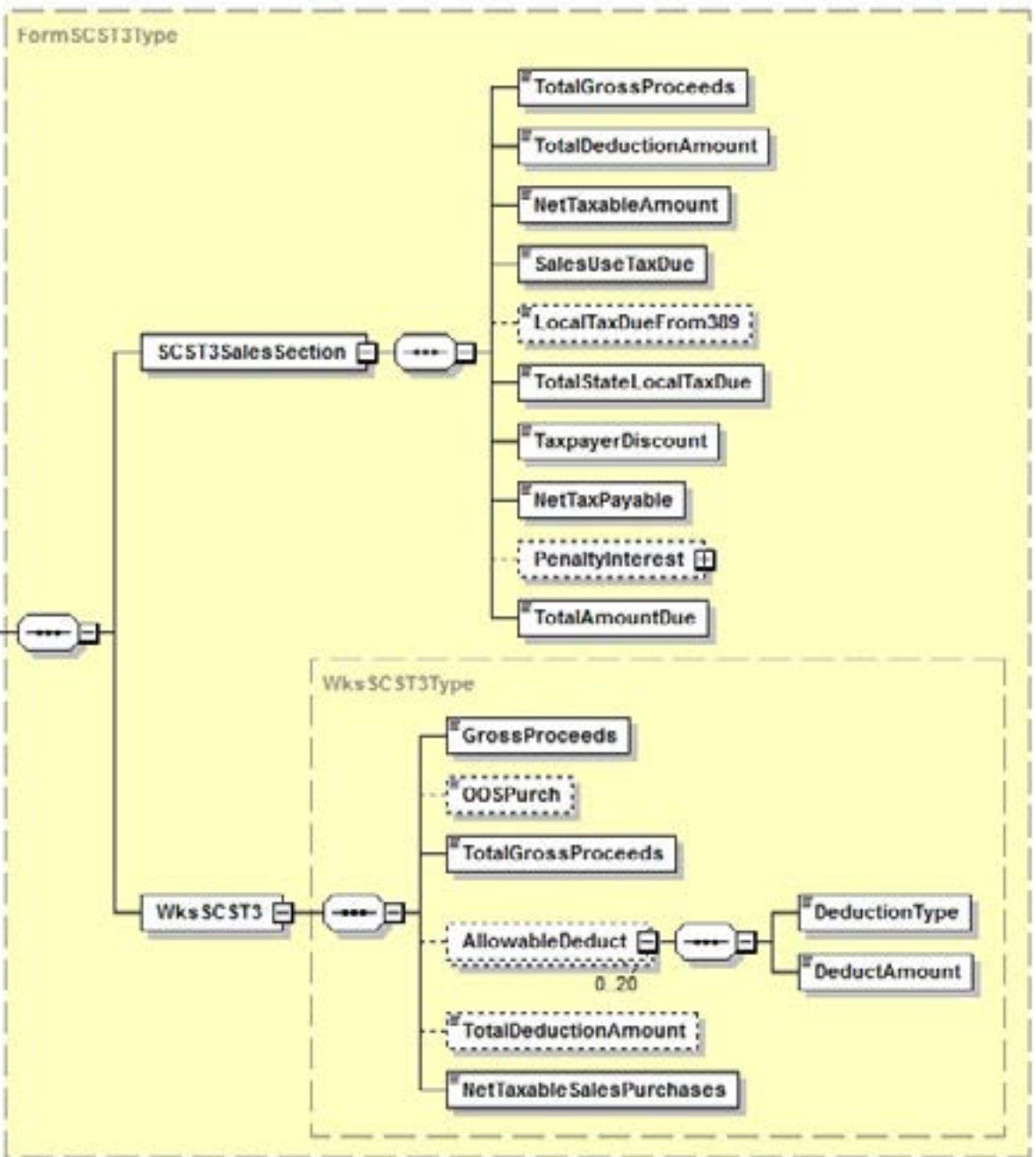

Generated by XMLSpy

www.altova.com

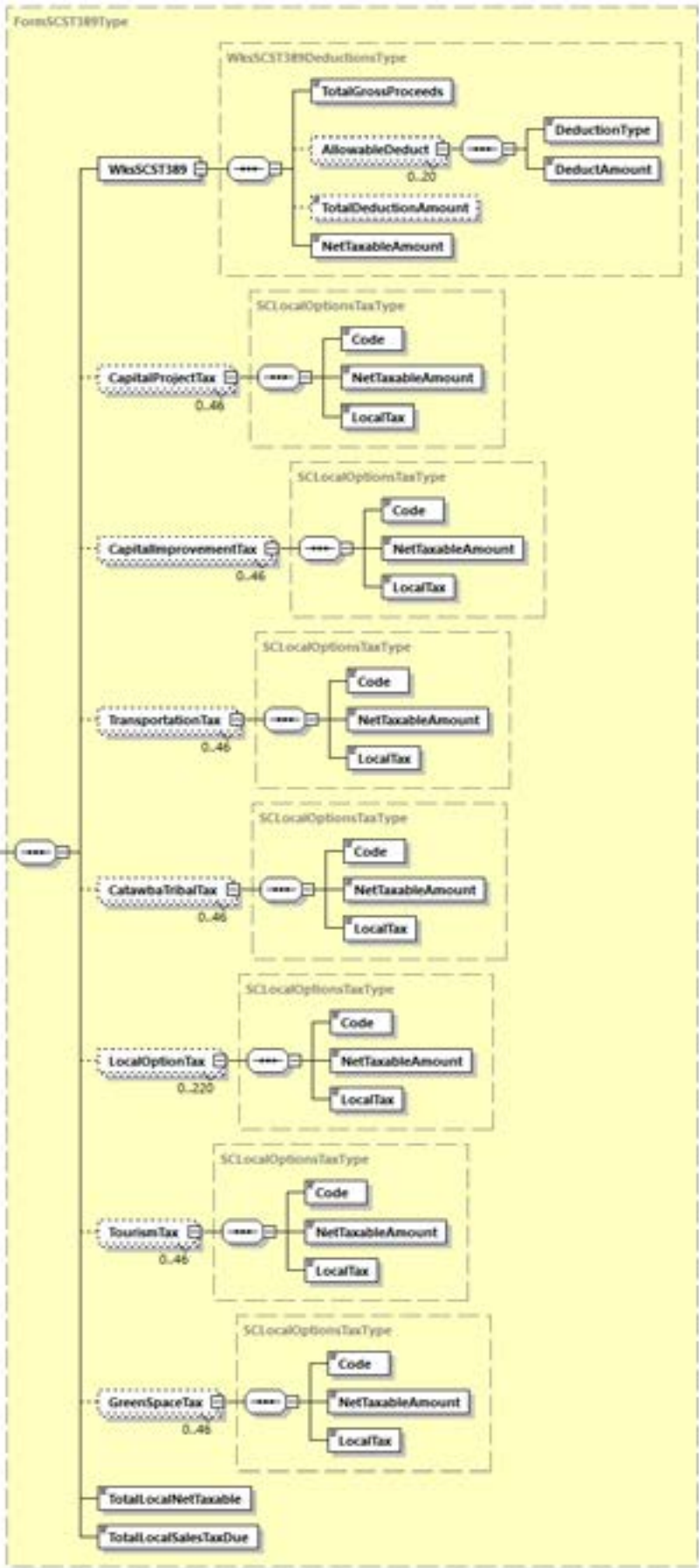

FormSCST389
 Root Element For South
 Carolina Form ST 389

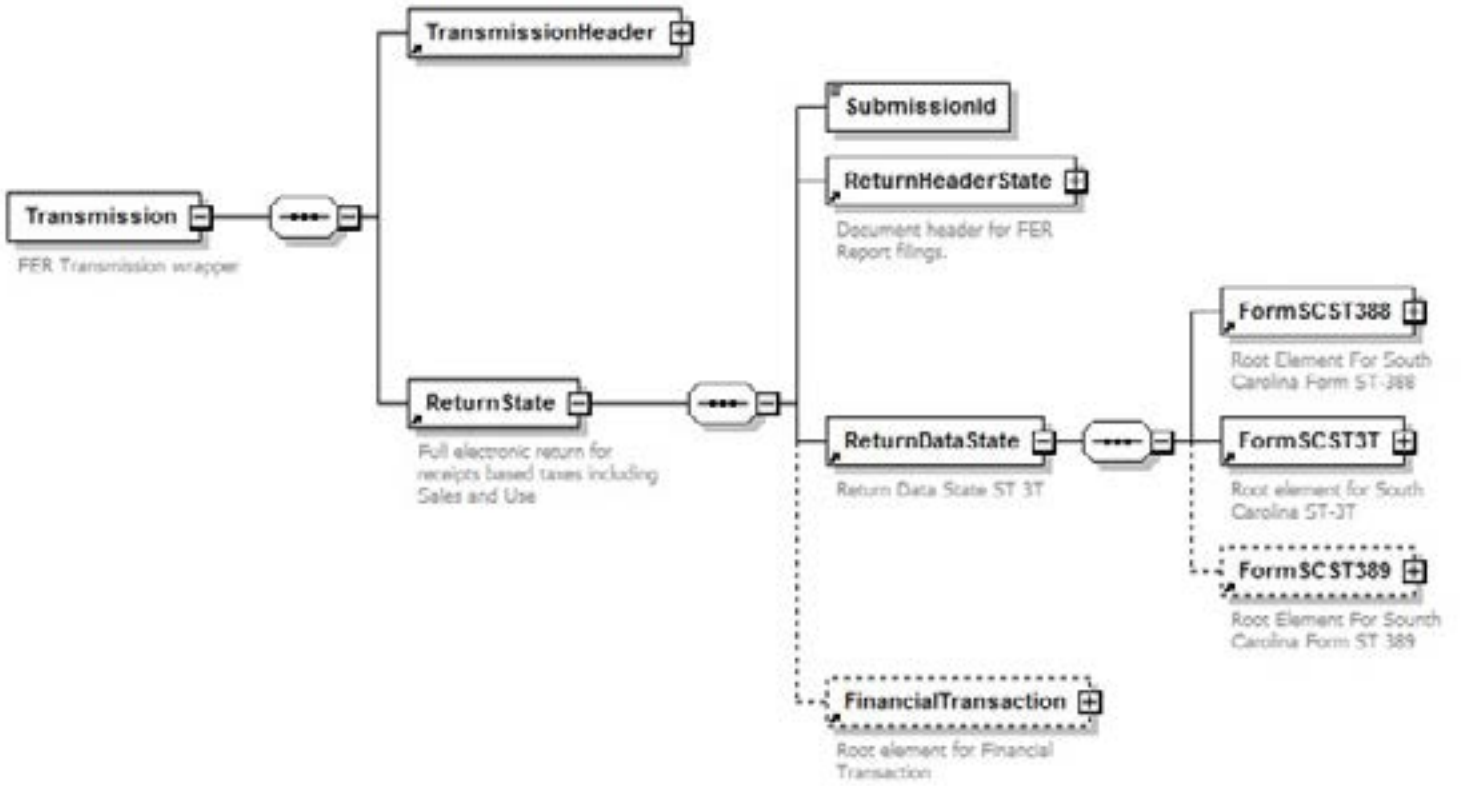

Generated by XMLSpy

www.altova.com

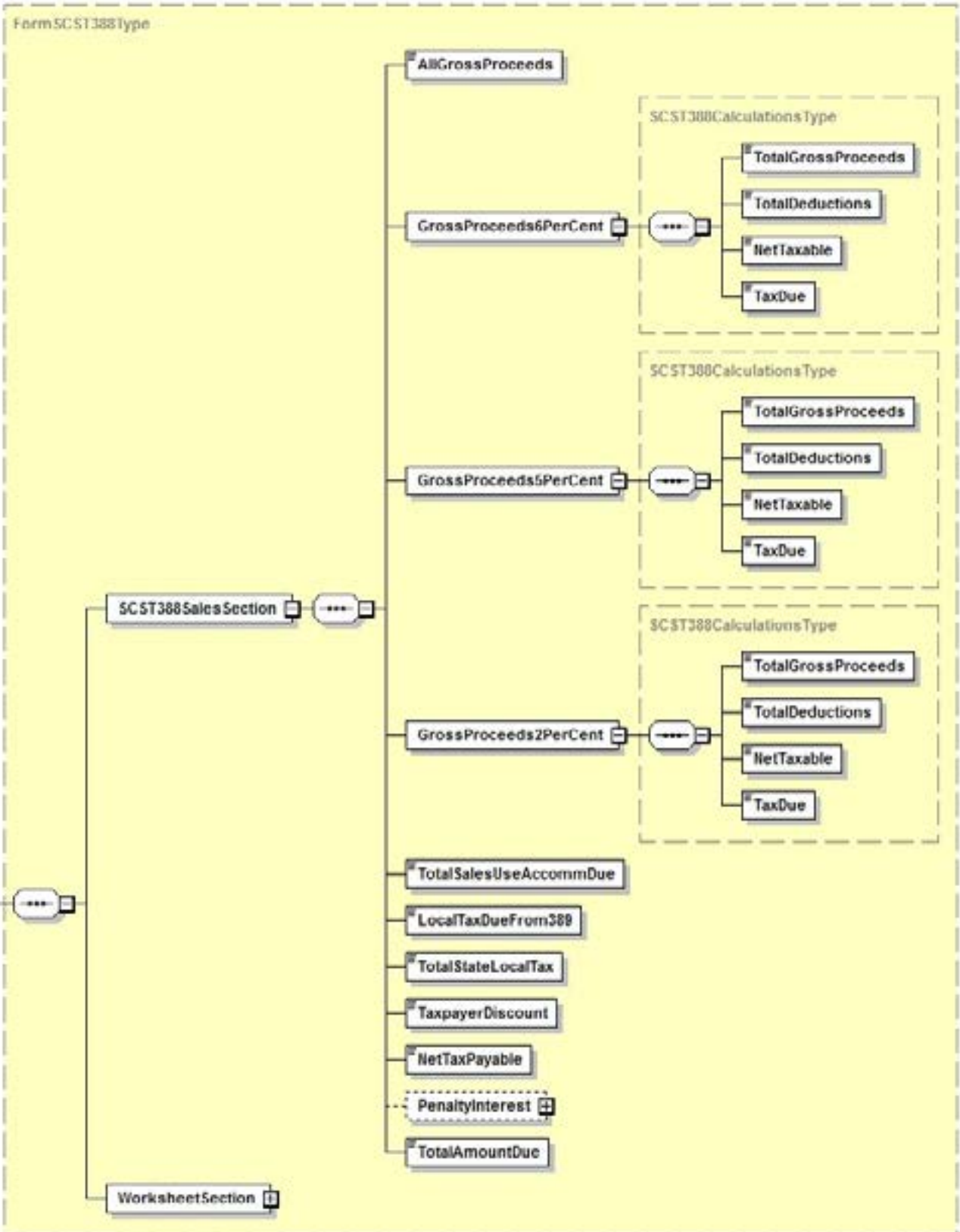

Generated by XMLSpy

www.altova.com

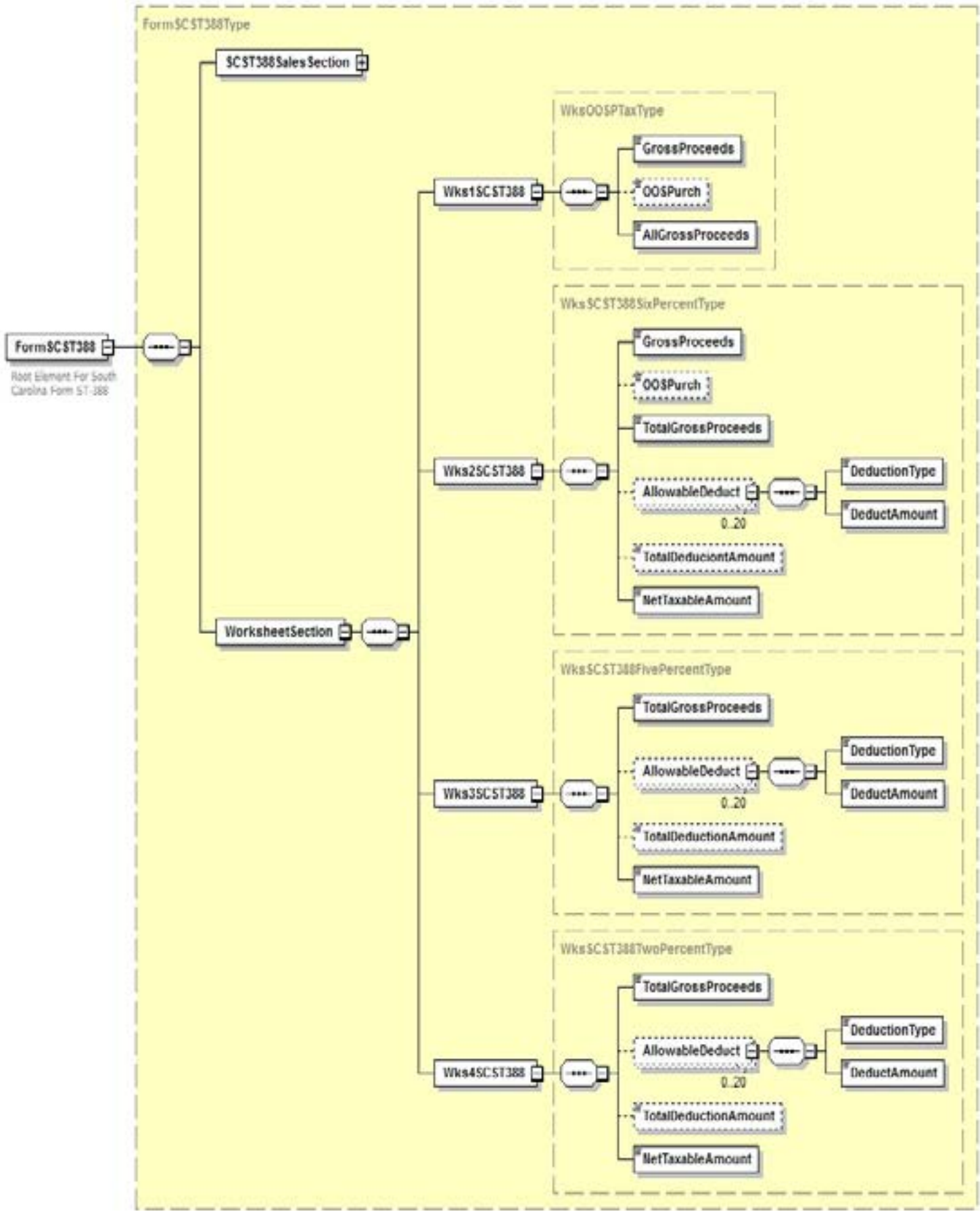

FinancialTransaction

The FinancialTransaction schema has two options, authorization of payment by ACH debit and notification of payment by ACH Credit. When making a single payment for a multiple-return filing, such as a multiple-location retailer, complete the FinancialTransaction for the last return only in the filing, indicating multiple returns by the AddendaRecord as described below.

For authorization of payment by ACH Debit, you must supply the following:

Within the **StatePayment complexType**:

- Place an “X” in either the Checking or the Savings element to indicate the type of account.
- Provide the Routing/Transit number and account number of the bank account to be debited in the RoutingTransitNumber and BankAccountNumber elements (EDI BPR13 and BPR15).
- Place the dollars and cents amount of the payment for **the entire filing** in the PaymentAmount element. Remember to include the period between dollars and cents. Rounding is not allowed.
- Place the identification number of the taxpayer – NOT the Retail License Number – in the IdentificationNumber element. This is the taxpayer's FEIN/SSN.
- The AccountHolderName and AccountHolderType are optional.
- Place the date that you want the payment funds to move in the RequestedPaymentDate element (EDI BPR16).
- The AddendaRecord is not used.
- Place an “X” in either the element NotIATTransaction or IsIATTransaction to indicate whether or not the funds will be taken from a foreign-owned account. The SCDOR does not use the FullIAT option.
- If this transaction is a Prenote, you must set the ProcessType element in the ReturnHeader to “T” for test, and the PaymentAmount must be greater than or equal to zero.

An ACH Credit Transaction is originated by the taxpayer. To indicate that payment is being made by ACH Credit, you must supply the following within the ACHCreditInfo complexType:

- Place the dollars and cents amount of the payment for **the entire filing** in the PaymentAmount element. Remember to include the period between dollars and cents. Rounding is not allowed.
- Place the identification number of the taxpayer – NOT the Retail License Number – in the IdentificationNumber element. This is the taxpayer's FEIN/SSN.
- Optionally you may indicate the date that the funds will move in the RequestedPaymentDate element.
- The AddendaRecord is not used.
- Place an “X” in either NotIATTransaction or IsIATTransaction as appropriate.
- If this transaction is a Prenote, you must set the ProcessType element in the ReturnHeader to “T” for test, and the PaymentAmount must be greater than or equal to zero.

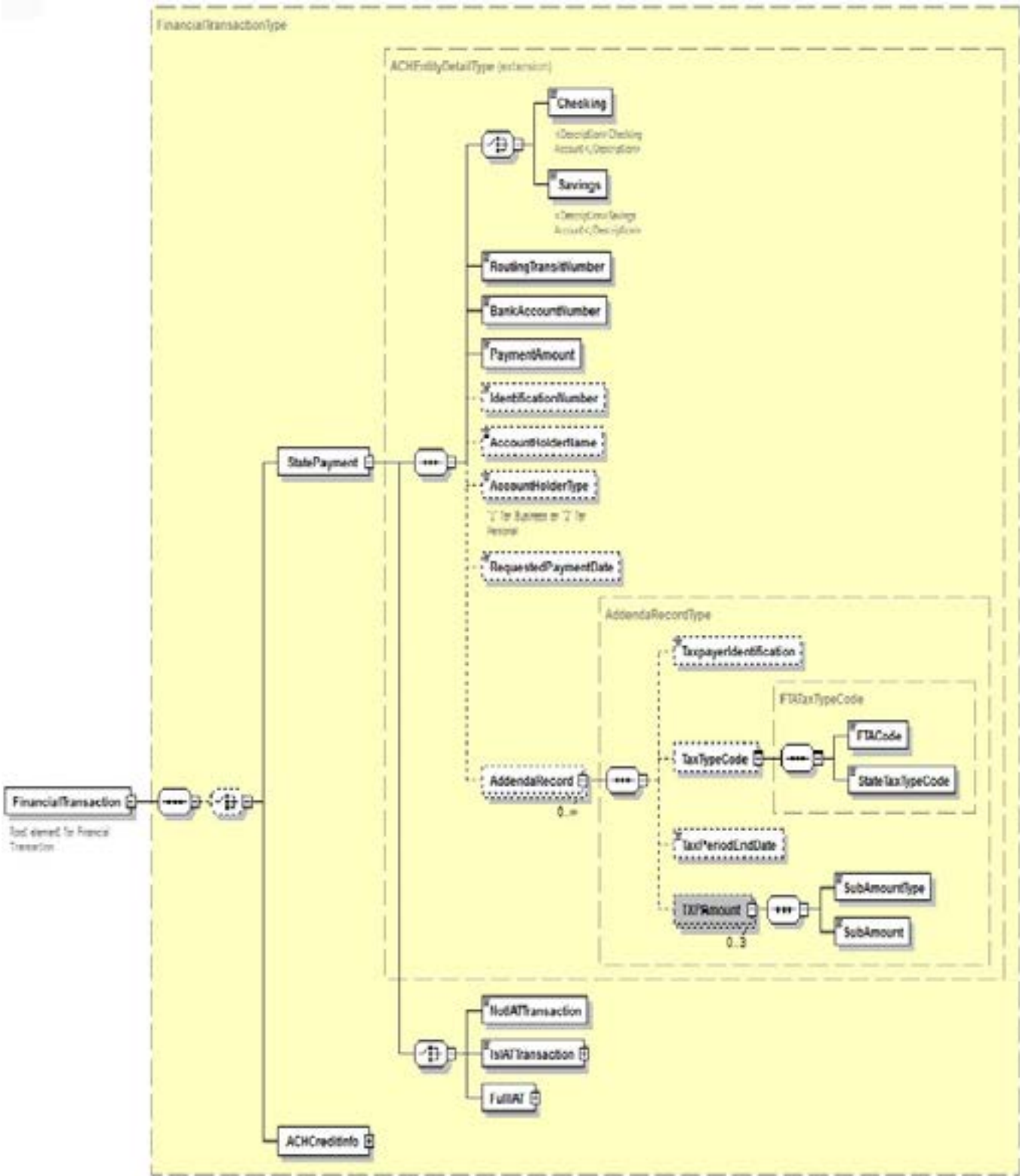

Generated by XMLSpy

www.altova.com

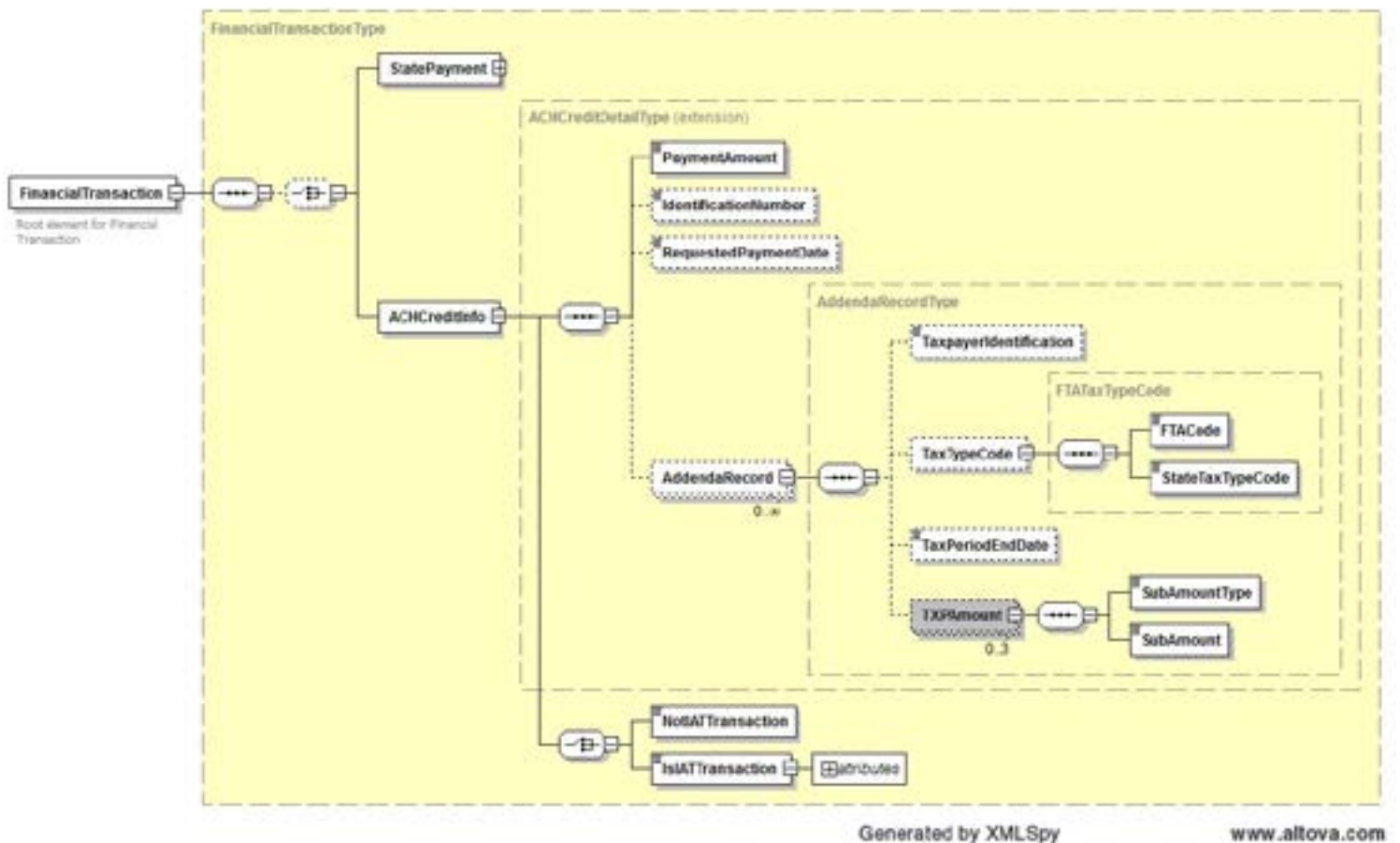

Additional Software Edits

The XML Schemas show most of the edits that will be performed on your XML. For example, all data elements of type USDecimalAmountNN must be numeric and non-negative, all data elements of type DateType must be valid dates in MMDDYY format, and all codes must be from the lists given. However, the additional edits that must be performed are listed below. We strongly recommend you incorporate these edits into your software to minimize the possibility that the XML will be rejected.

1. If the XML transaction being transmitted is a prenotification (prenote) for a debit account, then:
 - a. The test/production flag given in the TransactionHeader set to "T". **All return data sent with a prenote transaction will be considered test data.**
 - b. Use the StatePayment (ACH debit) branch of the FinancialTransaction schema.
 - c. The total payment amount given in the PaymentAmount field of the StatePayment **must** be greater than or equal to zero.
 - d. If a production file and the StatePayment option of the FinancialTransaction schema hold a single debit authorization, the PaymentAmount must be greater than or equal to zero.
2. The nine-digit bank RT (routing/transit) number given in the RoutingTransitNumber field of the StatePayment is eight digits plus a check digit. The check digit is calculated as follows: Multiply each digit in the RT number separately by its weighing factor. The weighing factors for each digit are:

Position: 1 2 3 4 5 6 7 8

Weights: 3 7 1 3 7 1 3 7

Add the results of the eight separate multiplications.

Subtract the sum of the addition from the next higher multiple of ten. The result of the subtraction is the check digit.

Example:

RT Number: 0 4 0 3 8 4 8 3

Weights: 3 7 1 3 7 1 3 7

Results: 0 28 0 9 56 4 24 21

Sum = 0 + 28 + 0 + 9 + 56 + 4 + 24 + 21 = 142

Check digit = 150 - 142 = 8.

3. In any of the tax form schemas, the sum of the DeductAmount (deductions) as given in the TotalDeductAmount field **cannot** be greater than the amount of gross proceeds as shown in the TotalGrossProceeds field.
4. **TAXPAYER'S DISCOUNT:** A taxpayer's discount may be claimed for timely filing a Sales and Use Tax return when the taxes due on the return are paid in full and by the due date. **No discount** is allowed if the return **or** payment is received after the due date. The discount is computed as follows:
 - a. If the total tax liability shown on line 6 of the ST-3 return is less than \$100, the discount rate is 3% (.03) of line 6. Deduct this amount from line 6.
 - b. If the total tax liability shown on line 6 of the ST-3 return is \$100 or more, the discount rate is 2% (.02) of line 6. Deduct this amount from line 6.

NOTE: Taxpayers who file and pay electronically are allowed a \$3,100 maximum discount per taxpayer (for all locations) during any one South Carolina fiscal year, which covers payments made from July 1 through June 30. This includes all returns which become due during this period (returns for June through May). The \$3,100 maximum discount is calculated based on the total taxes due (sales/use and local taxes) on the return.

The discount amount is \$10,000 for out-of-state retailers who cannot be required to register for Sales and Use Tax but who voluntarily register to collect and pay the tax. However, the taxpayer must receive prior approval from the SCDOR for the \$10,000 discount.

When claiming the discount amount allowed on tax return, the taxpayer must not claim a discount amount that exceeds the maximum amount allowed. Any discount amount claimed in excess of the maximum amount allowed will be assessed for the difference.

5. The table of valid County and Municipality and jurisdictional codes is located in the **ST-389 Instructions** available at dor.sc.gov/forms. Please use current year instructions.

NOTE: The taxpayer must be able to report Local Option Sales Tax under the County codes or the Municipality codes. Local Option Sales Tax should be reported under a Municipality's 4-digit code **if the goods being delivered are being delivered within a Municipality**. If goods are being delivered to a location not located within a Municipality, sales would be reported under the County's 4-digit code.

6. Negative figures are **never** allowed.
7. **All** dollar fields must be numeric and in dollars and cents, with the period entered between dollars and cents amounts. Rounding is not allowed.
8. **DEBIT TRANSACTIONS:** The SCDOR does provide a warehousing capability for debit taxpayers. To utilize warehousing, RequestedPaymentDate must be a date greater than the projected date of transmission. If not, BSWA will default to next banking day for settlement.
9. It is critical that software programs be capable of translating error messages into user-friendly language for correction purposes. If the codes are not translated within the software, taxpayers will be referred to software developers for translation of any error messages.
10. Freeze all data after each transmission to ensure a proper audit trail. Do not allow transmitted data to be altered.

Acknowledgement Overview

The transaction and return acknowledgment will be provided in the format of an XML document according to a national standard schema. It is described and pictured below. The elements of the Acknowledgment schema are as follows.

- The SubmissionId is the same identification number as in the ReturnState, which uniquely identifies the return being acknowledged.
- The next element is StateEIN, which contains the taxpayer SID as given in the TransmissionHeader.
- TaxYear is required. Jurisdiction is “SC” to indicate a South Carolina return.
- SubmissionType indicates the type of filing, and will equal the ReturnType of the return being acknowledged.
- SubmissionCategory must equal “FER”.
- ElectronicPostmark is not used.
- AcceptanceStatus gives the status of the return. It will either be “A” for an accepted return or “R” for a rejected return.
- ContainedAlerts will equal “0” because alerts are not used for this program.
- StatusDate is the date that the return was processed and either accepted or rejected.
- In the next element, which is a choice, StateEIN contains the Retail License Number of the return being acknowledged.
- TaxPeriodEndDate contains the end date of the return period.
- PaymentIndicator will contain the expression “Payment Request Received” if there is an ACH debit payment authorization in the FinancialTransaction of the return being acknowledged. If no debit was requested, the element is not used. It is not used for payment by ACH credit.
- CompletedValidation will equal “0” if for some reason the return cannot be completely processed; otherwise it is not used.
- Optionally, the balance due on the return will be stated in the BalanceDue element.

- If there are any errors in the return, they will be listed in the ErrorList element. The ErrorCount attribute gives the count of errors. If there are no errors in the return, the element will not be used. The ErrorList contains one or more errors, each given in an Error element.
 - The ErrorId attribute contains an identification number for the error, used to number the errors in sequence.
 - DocumentID again contains the SubmissionID of the return being acknowledged.
 - XPath gives the entire XPath through the XML return being acknowledged of the element in error for this Error.
 - ErrorCategory gives the class of error, such as missing element or invalid date.
 - ErrorMessage contains a text message describing the specific error.
 - RuleNumber will equal the Error attribute.
 - Severity will contain the work “Reject”.
 - DataValue will contain the contents of the element in error if possible.
 - AlertList is not used.

