

Red Drum
Natural History and Fishing Techniques
in South Carolina

by
Dr. Charles Wenner

Educational Report No. 17



Marine Resources Research Institute
Marine Resources Division
South Carolina Department of Natural Resources
P.O. Box 12559
Charleston, SC 29422

Original Printing
October 1992

PREFACE

In the summer of 1986, the Marine Resources Research Institute of the South Carolina Wildlife and Marine Resources Department began intensive studies of the natural history and dynamics of recreationally important inshore fishes in our estuaries and bays. The major objective of these studies was to obtain the scientific knowledge required to develop policies and regulations that protect and maintain these economically and ecologically valuable resources, including red drum, spotted sea trout, and southern flounder. This publication is the first in a series that is being developed to distribute the findings of these studies to the angling public. In addition to information about natural history, we have also included a section on fishing techniques designed to assist readers, particularly beginning anglers, in their piscatorial pursuits as well as a section explaining the approach and rationale for conservation efforts that have been or soon will be proposed. As a result of this work, I hope the recreational fisherman will gain a better understanding and appreciation of the actions that are required to ensure that an abundant supply of fish is available for future generations.

It has been said by men who are much wiser than I, that the Lord does not subtract the days spent fishing from an individual's allotted time on earth. As I approach my 50th birthday, I more fully realize how precious is the time spent in the peaceful pursuit of fish. The following poem, which was the favorite of my late father-in-law, Roland Lewis, puts into words my feelings about fishing in a more meaningful way than I am able to accomplish.

I hope the reader enjoys this publication, and I would appreciate any comments and suggestions that would assist in making future editions of the planned series more informative and useful.

Charlie Wenner

ADDENDUM

Since this booklet was first published, indeed shortly after it was released to the public, Colonel James P. Rathbun passed away after a battle with cancer. He was an extremely honest and courageous man who was willing listener. Frequently, when faced with a difficult situation that requires honest thought, I say to myself "How would the Colonel handle this? What would he say?" Frequently I wish I could simply call him up and ask his opinion on some matter dealing with our natural resources, or just to say hello. South Carolina is indeed a better state for having had this man as a citizen. Recreational anglers as well as all those who love the beauty and resources of our coastal area have better opportunities because of this man. Indeed, he was a positive influence on my life and I sorely miss his candor, good humor, and integrity.

THE FISHING CURE¹

by
Edgar A. Guest

There's nothing that builds up a toil-weary soul
Like a day on a stream,
Back on the banks of the old fishing hole
Where a fellow can dream.
There's nothing so good for a man as to flee
From the city and lie
Full length in the shade of a whispering tree
And gaze at the sky.

Out there where the strife and the greed are forgot
And the struggle for pelf,
A man can get rid of each taint and each spot
And clean up himself
He can be what he wanted to be when a boy,
If only in dreams;
And revel once more in the depth of a joy
That's as real as it seems.

The things that he hates never follow him there -
The jar of the street,
The rivalries petty, the struggling unfair -
For the open is sweet.
In purity's realm he can rest and be clean,
Be he humble or great,
And as peaceful his soul may become as the scene
That his eyes contemplate.

It is good for the world that men hunger to go
To the banks of a stream,
And weary of sham and of pomp and of show
They have somewhere to dream.
For this life would be dreary and sordid and base
Did they not now and then
Seek refreshment and calm in God's wide, open space
And come back to be men.

¹ from A Heap o' Livin' by Edgar A. Guest, published in 1916 by The Reilly & Lee Co., Chicago, Illinois.

ACKNOWLEDGMENTS AND DEDICATION

Support for the research that supplied much of the information that I have used to describe the natural history of the red drum was provided by the Sport Fish Restoration Fund that is administered by the United States Fish and Wildlife Service. The money in this fund is derived from excise taxes on sport fishing equipment, so in essence, you the angling public have supported this work.

I would have never been able to learn about red drum in South Carolina without the assistance of the following biologists and students who work with me at the Marine Center at Fort Johnson: Bill Roumillat, Mark Maddox, John Archambault, Louie Daniel, Joe Moran, and George Reikerk. Fred Holland carefully edited the text and made it much more understandable, however, any errors are mine. Karen Swanson carefully turned my stick diagrams into good looking figures and made the camera ready copy of the document.

I have never really written anything that I could have dedicated to anyone. Should I dedicate this to my loving wife to whom I have been married for 16 years; to my Dad, who first took me fishing, or perhaps my Mom who suffered through my many indiscretions; to the memory of Billy Sales, a wise old drum fisherman of the Outer Banks of North Carolina who first called me "Damn Yankee" and instructed me in the fine art of throwing a large diameter cast net when you have no teeth to hold the lead line (he used a spring clamp that was hung around his neck); to Jack Musick who took me on my first trip to the Outer Banks; to Dee Oliver who first introduced me to the habits of "Sweet William" (old Billy Bass) in South Carolina?

All are indeed deserving of acknowledgment, however, I would like to take this opportunity to dedicate this work to Colonel James P. Rathbun. If he approached his duties as a United States Marine with the same energy as he has championed the cause of the wise use of South Carolina's fishery resources, he must have been one hell of a soldier. Thanks Colonel. Your efforts on behalf of future generations of South Carolinians is gratefully acknowledged.

CHANGES IN REGULATIONS

Since this booklet was first published, there have been some changes in the laws that regulate the harvest of this species. The following are regulations that are in place as of 1 January 1996. The prudent fisherman will keep abreast of any changes in the laws after this time.

1. Size limits: minimum size - 14 inches total length maximum size -27 inches total length
2. Catch limits : five (5) fish per angler per day - no red drum may be harvested from Federal Waters which lie beyond 3 miles to the off-shore boundary which is 200 miles at sea.
3. Gear Restrictions: can be taken only with rod and reel year-round or by gigging during March through November

Red drum are a gamefish in South Carolina. Native fish caught in the State's waters can not be legally sold. Fish from states where their harvest is legal may be sold in South Carolina with proper documentation; also those fish produce in a mariculture (fish farming) operation may be sold with proper documentation.

INTRODUCTION

Fishes are given two types of names: a scientific name which is derived from the Latin or Greek language, and an official common name designated by the American Fisheries Society in an attempt to standardize public usage across the nation. The scientific name of the subject of this publication is *Sciaenops ocellatus* (*Sciaenops* - Greek word meaning a perch-like marine fish; *ocellatus* - Latin word meaning an eye-like colored spot), and the common name is red drum. Most anglers in coastal South Carolina, however, call this fish "spot-tail bass" or simply "spot-tails." To fishermen in states that border the Gulf of Mexico and along the east coast of Florida, this species is known as "redfish" because of the bronze coloration. In Virginia, red drum are called "channel bass." Anglers in North Carolina refer to red drum less than 15 pounds as "puppy drum," those 15 to 30 pounds as "yearlings," and those heavier than 30 pounds are simply "drum." Throughout the text, I will use the accepted common name, red drum.

The red drum is a member of the family Sciaenidae (= drum family) which includes several species that are sought by inshore fishermen. Some of the red drum's relatives found in coastal South Carolina are the black drum, spotted seatrout (= winter trout), weakfish (= summer trout), kingfishes (= whittings), Atlantic croaker, and spot (Figure 1).

Red drum are found along the Atlantic coast of the United States from the eastern shore of Delaware to southern Florida. In the Gulf of Mexico, they range from southern Florida to northeastern Mexico (Figure 2). Samuel F. Hildebrand and William C. Schroeder in their classic 1928 book entitled, "Fishes of the Chesapeake Bay," reported that north of Cape Hatteras, North Carolina, red drum were most abundant in spring through fall, and this species was a favorite

target of surf fishermen along the New Jersey coast. Presently, however, red drum are rarely encountered north of the eastern shore of Virginia. This is possibly a result the decline in their abundance that has occurred over the last several decades. In general, as abundance of a species declines, its range shrinks to areas that provide the most favorable habitat.

Red drum generally are an iridescent silvery grey with a coppery cast which is darker on the back than on the belly. The tip of the tail of young red drum, 10 to 18 inches long is a beautiful silvery blue which disappears in larger fish. However, the intensity and proportions of the color of red drum depends to a degree upon where you catch him. Red drum taken in brackish or low salinity water (salinity is the amount of sea salts dissolved in water; full strength seawater contains about 36 pounds of salt for every 1000 pounds of seawater) have a dark, copper color; whereas individuals taken in the surf are more silvery. Many fishes change color to blend in with their surroundings. If red drum remained dark when they moved from the rivers to the ocean, they would be easier to see against the white, sandy bottom of the coast than if their color became lighter and more silvery.

In our state, the red drum goes by spot-tail bass because of the dark spot near the tail. Many red drum have more than one spot. The most that I have seen was 12: five spots on the left side and seven on the right. Predators often strike prey on the area around the eye, and scientists believe that the spot near the tail may divert predator attacks from the vital head region allowing the attacked fish to escape.

Red drum grow to about 100 pounds. The all tackle record documented by the International Game Fish Association (IGFA) is 94 pounds 2 ounces. This fish was caught on November 7, 1984 at Avon on the Outer Banks of North Carolina by David G. Deuel. The South Carolina state record fish of 75

Spotted seatrout (Winter trout)
Cynoscion nebulosus

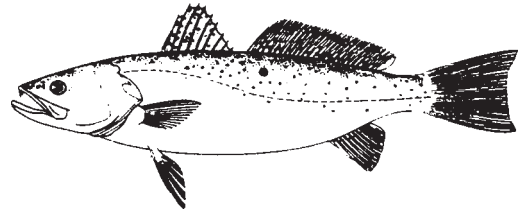

Weakfish (Summer trout)
Cynoscion regalis

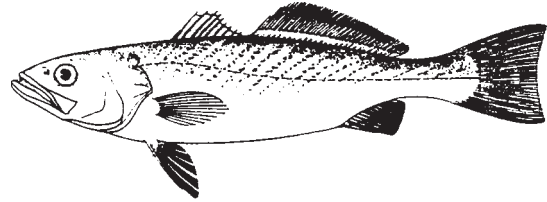

Spot
Leiostomus xanthurus

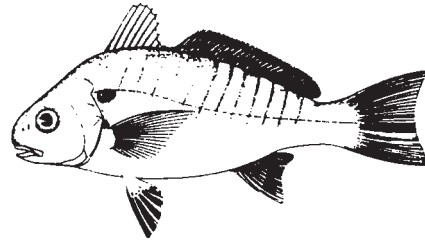

Atlantic croaker
Micropogonias undulatus

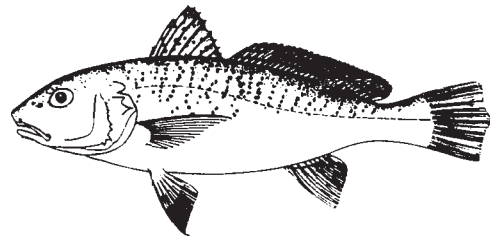

Black drum
Pogonias cromis

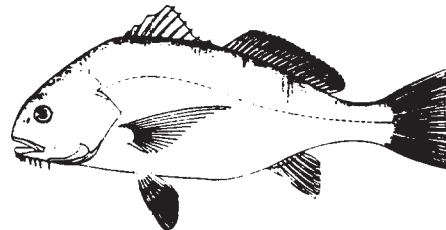

Kingfishes (Whitings)
Southern kingfish (pictured here)
Menticirrhus americanus
Gulf kingfish
Menticirrhus littoralis
Northern kingfish
Menticirrhus saxatilis

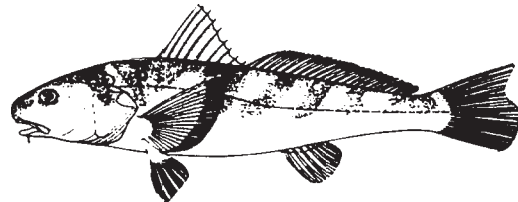

Red drum (Spot-tail bass)
Sciaenops ocellatus

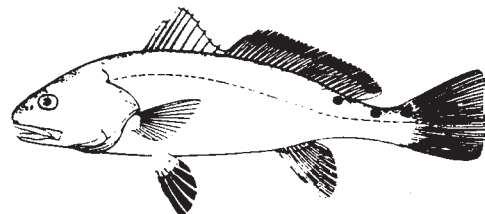

Figure 1. Common relatives of red drum found in South Carolina.

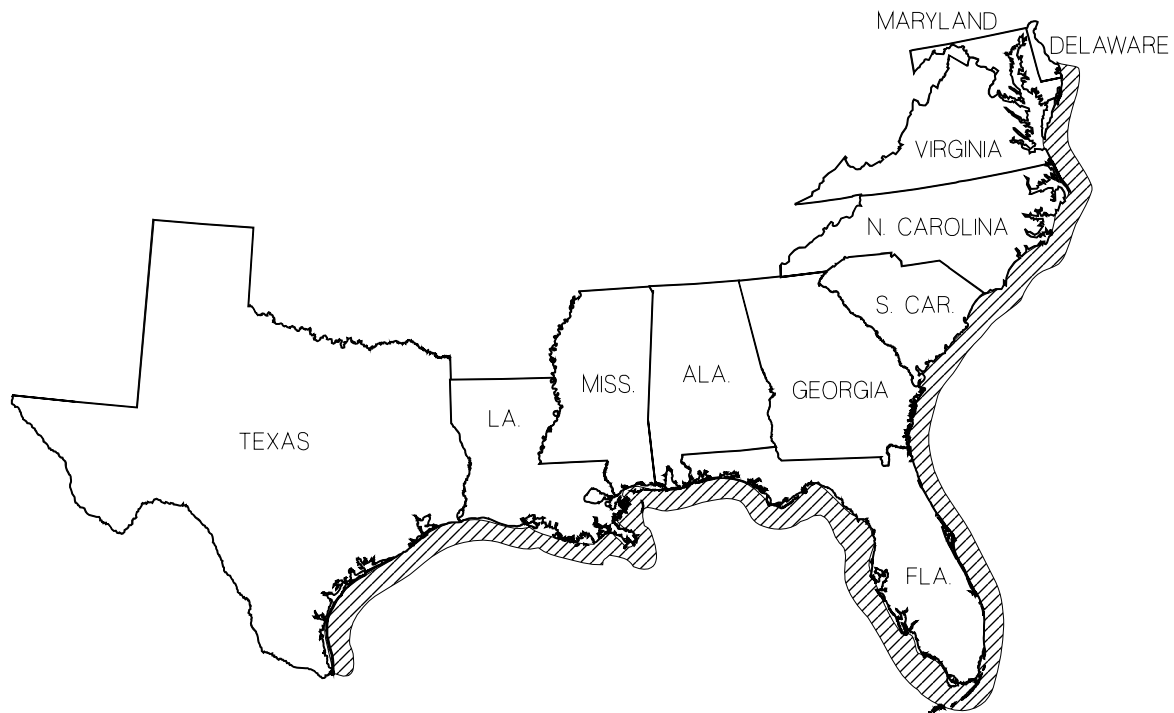

Figure 2. Distribution of the red drum along the southeastern coast of the United States and in the Gulf of Mexico.

pounds 0 ounces was taken by A.J. Taylor in 1965 at Murrells Inlet. The IGFA saltwater line class records are in Table 1 to provide readers targets to shoot for in their angling pursuits.

THE JUVENILES (OR EARLY LIFE STAGES)

We have been sampling the small creeks that wind through the *Spartina* (cordgrass) marshes since the spring of 1986 to determine the value of estuarine marshes and creeks as nursery habitat for fish. To accomplish this goal, we have to determine what small fish use these creeks as nursery grounds, when they use them, how long they remain there, how fast they grow, and what they eat. The majority of the creeks we studied were in the Coosaw River near St. Helena Sound, and off the South Edisto, Stono and Wando Rivers. Samples were collected once a month around low tide when fishes, crabs and shrimp that were spread

out on the flooded marsh surface and mud flats at high tide were concentrated in the small creeks. At this time we had a much better chance of obtaining a good sample.

Our initial observations found that the small creeks that cut into the marsh and have some water in them at low tide are important habitat for juvenile red drum. Red drum juveniles first appeared in these creeks in August, and continued to move into them until early October when the highest abundances were consistently observed (see Figure 3). When juveniles first arrive in the creeks, they are about one-half inch in total length (this is the length of the fish measured from the tip of the nose to the tip of the tail). As the water temperatures began to decline in December, the number of juveniles occurring in small creeks rapidly declined. From January through March when the water was coldest (near 50 F), very few red drum juveniles were found in shallow creeks. The only places we have consistently found juvenile red drum during winter is in

Table 1. Salt water line class records for red drum as published by The International Game Fish Association, 300 E. Las Olas Blvd., Fort Lauderdale, Florida 33316- 1616 in 1990. M = men's class; W = women's class. weight = pounds - ounces.

Line Class	Weight	Place	Date	Angler
M - 2 lb	12 - 13	New Smyrna Beach, FL	Aug, 31 1986	D.M.Fairbanks
M - 4 lb	22 - 13	Empire, LA	Mar 13, 1982	M.F.Claverie
M - 8 lb	60 - 8	Oregon Inlet, NC	June 7, 1987	S.C. Lee
M - 12 lb	69 - 3	Gwynns Island, VA	July 10, 1975	J.O. Everett
M - 16 lb	57 - 0	Wreck Island, VA	Oct 19, 1984	H. Gabler
M - 20 lb	72 - 7	Hatteras Island, NC	Nov 27, 1973	W. Plageman
M - 30 lb	90 - 0	Rodanthe, NC	Nov 7, 1973	E. Hooper
M - 50 lb	94 - 2	Avon, NC	Nov 7, 1984	D. G. Deuel
M - 80 lb	(vacant - minimum weight for entry is 68 lb)			
W - 2 lb	11 - 6	Flamigo, FL	July 7, 1984	B. Earle
W - 4 lb	15 - 4	Lake Braunig, TX	Sept 23, 1984	V. J. Hernandez
W - 8 lb	39 - 10	Ocracoke, NC	Nov 15, 1988	Mrs. W.B. DuVal
W - 12 lb	51 - 8	Cape Hatteras, NC	Nov 19, 1958	J.S. Dull
W - 16 lb	60 - 4	Avon, NC	Nov 5, 1984	J. Hinson
W - 20 lb	65 - 0	Cape Hatteras, NC	Nov 11, 1983	L. Gottert
W - 30 lb	69 - 8	Cape Hatteras, NC	Nov 16, 1958	J. Browning
W - 50 lb	70 - 4	Oregon Inlet, NC	May 28, 1985	E.Z. Pomory
W - 80 lb	(vacant - minimum weight for entry is 68 lb)			

the main channels of the rivers at depths of 30 to 50 feet and salinities that are one-half to two-thirds that of seawater. In spring, when the waters warm, juveniles moved back into the shallow creeks and were most abundant in late spring. In June and July, when the fish are 10 months old and becoming subadults, they migrate from the creeks and begin to occupy other habitats (see next section) just as the next year's juveniles are beginning to migrate into them. The spatial separation of the very young and the one year old fish reduces cannibalism and competition.

The juveniles which were approximately one-half inch long in August when they first moved into the creeks, increased to two inches in length by November. The young red drum grow very little from December through March (see Figure 4). Fishes are cold blooded animals and their body temperature is the same as that of the surround-

ing water. During winter, they are relatively inactive, eat very little and do not grow. In extreme winters they may actually decrease in weight. In spring and early summer, as the water in the estuaries warm, red drum juveniles grow rapidly increasing in size at the rate of 1½ inches per month. By July when the young red drum migrate from the shallow creeks, their average length is between 7 and 8 inches.

The smallest red drum feed mainly on small shrimp-like organisms called opossum shrimp. As they grow, the size of food items in their diet also increases. Juveniles 2 to 3 inches long feed mainly on grass shrimp and small fishes such as juvenile spot and mummichogs (these are commonly known as mud minnows in coastal South Carolina). Red drum around seven inches in length eat mud crabs (these are the small crabs that you frequently find around oyster bars), fiddler crabs, and small fishes (Figure 5).

Number of Juvenile Red Drum in Creek Samples: 1986-1991

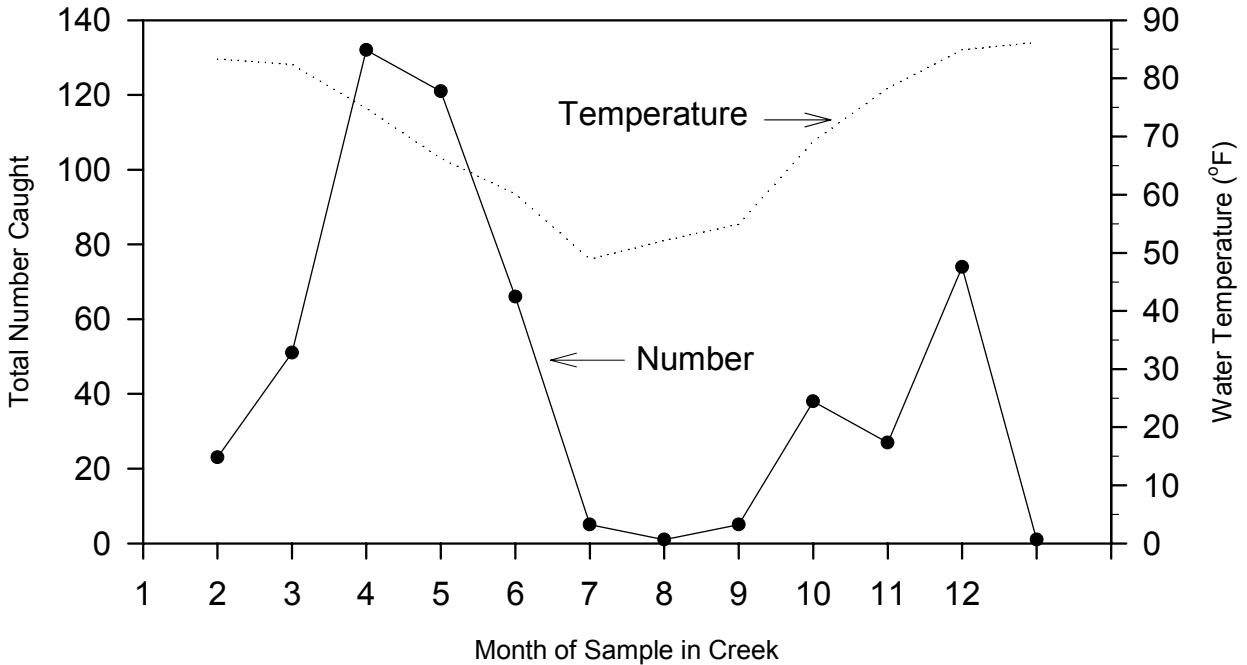

Figure 3. The total number of juvenile red drum caught in four samples in shallow creeks each month (solid line) and the water temperatures at that time (dotted line). Note the catches are very low from January to March when water temperatures are at their lowest.

Average Size of Juvenile Red Drum in Creeks

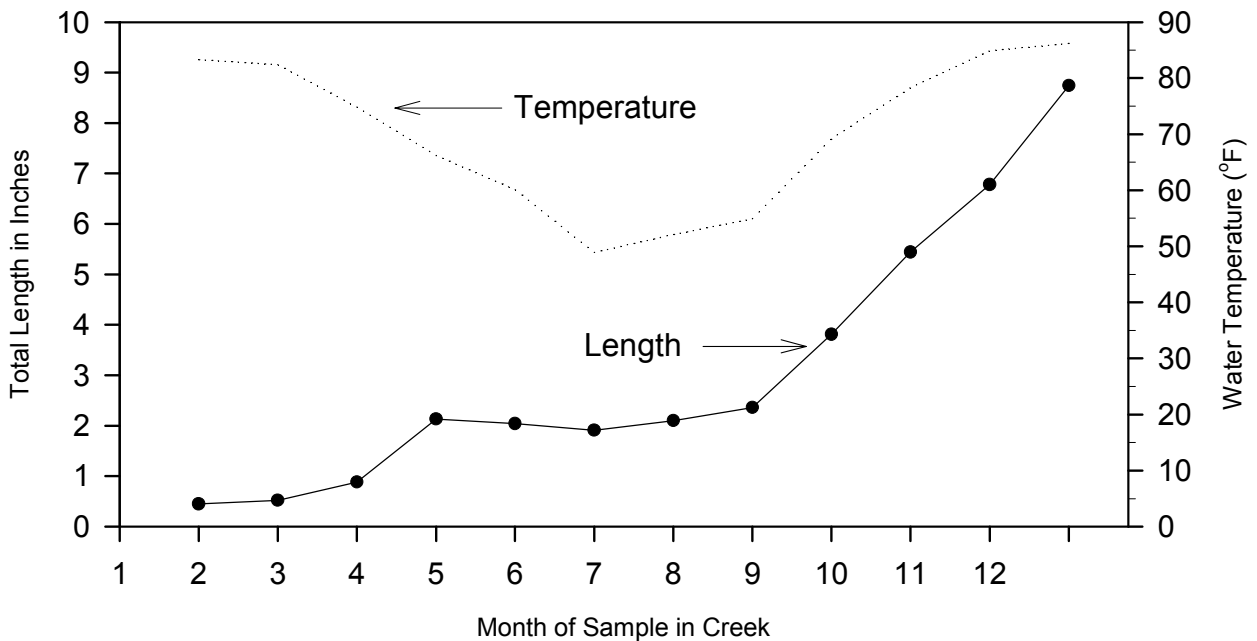
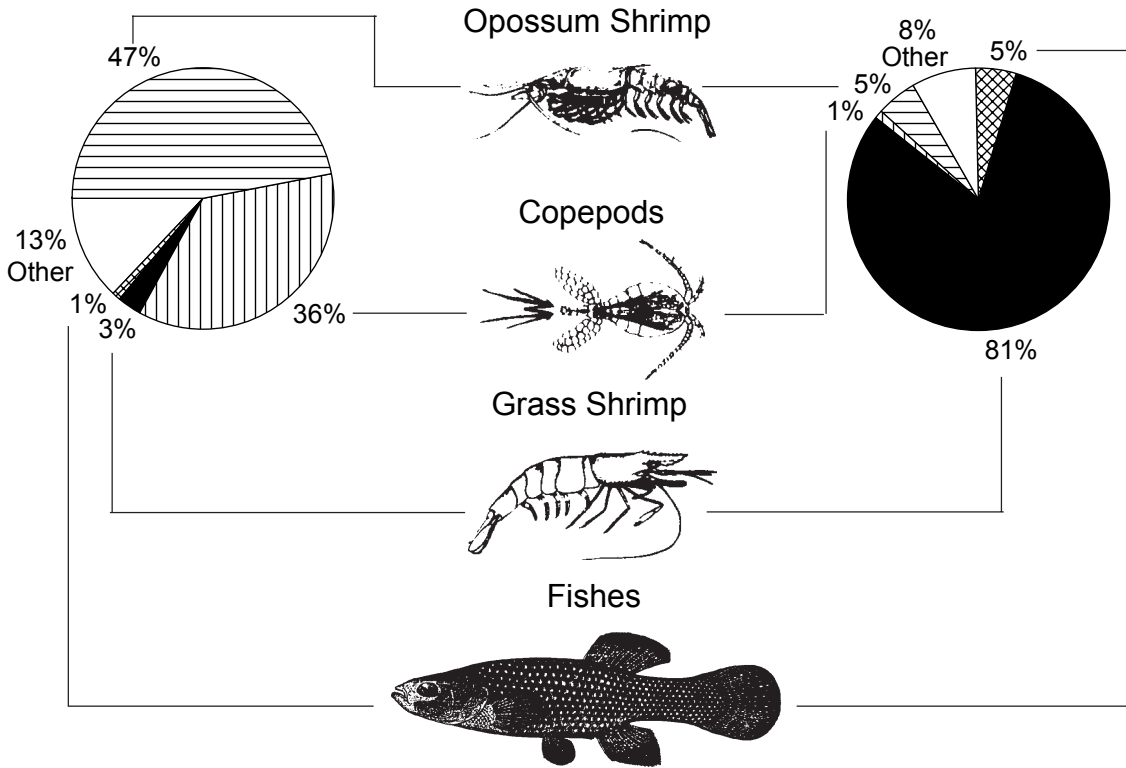

Figure 4. The average size of juvenile red drum in shallow creeks each month. Note that during cold months, the size changes little however, as the water becomes warm in spring, growth is rapid.

Percent of the Diet by Numbers

Percent of the Diet by Volume

~ 1/2 to 3 1/2 inches total length



3 1/2 to 7 inches total length

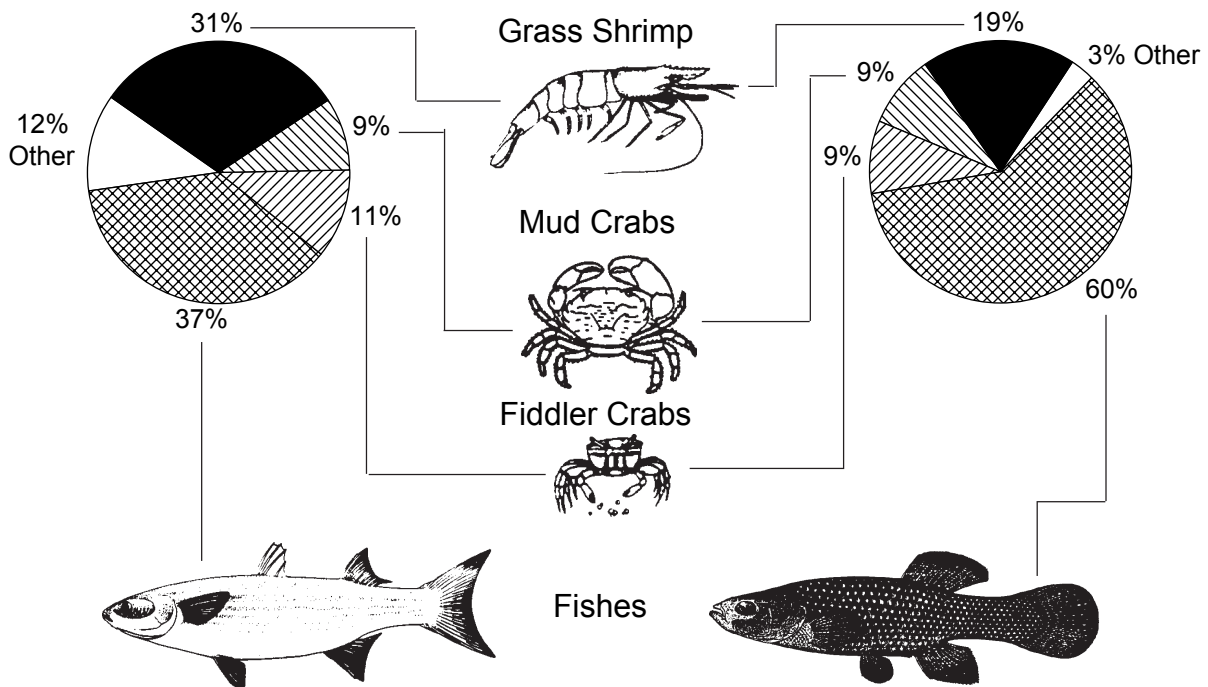

Figure 5. Food of juvenile red drum.

SUBADULTS

The subadult phase in the life cycle of the red drum is the period between their exit from the shallow nursery habitat at age 10 months and the attainment of sexual maturity which occurs at about age 3 to 5 years. During this time red drum mainly inhabit larger tidal creeks and rivers, although some subadults may also be found along the front beaches of the barrier islands, around inlets near jetties and sand bars. Some have even been caught on nearshore artificial reefs. Red drum may leave their nursery grounds as a group since recreational anglers catch and release many sub-legal red drum in July and August around oyster bars, rocks and pilings in the larger creeks and main rivers. In the four month period between 10 months of age when they leave the nursery creeks and 14 months of age, red drum increase in average length from about 9 inches to almost 14 inches for a growth rate of 1.25 inches per month. Most red drum reach the minimum legal size of 14 inches in October and November. During this period of rapid growth, the increases in weight are dramatic. At an age of 10 months, a 9 inch long, red drum weighs about ~ 4 ounces. Four months later red drum average slightly more than a pound which translates into a growth rate of about a quarter of a pound per month. Table

2 may give the reader a better idea of the growth of red drum during their subadult phase.

After leaving the nursery habitat and moving to the larger creeks and along the banks of the lower parts of the river systems that make up South Carolina's estuaries, the diet of red drum changes. Over 94% of the food items in the stomachs of subadult from red drum between 7 and 11 inches in length were crustaceans (crabs and shrimp). The other 6% was fishes, mainly mummichogs (mud minnows). The most abundant prey were fiddler crabs which made up almost half the diet. Mud crabs, blue crabs, and grass shrimp also were important. Commercially and recreationally harvested penaeid shrimps (brown, white and pink shrimp), however, were not an important food item in the diet of subadult red drum. This finding was a surprise since the preferred baits used by recreational anglers to catch young red drum are penaeid shrimps (Figure 6).

Seasonal changes in the growth are reflected in the density of the bones and scales of red drum much in the same manner as rings reflect seasonal growth patterns in trees. Therefore, to determine the age of a fish, we use the same process foresters use to age trees. We count the rings in the bones and/or scales. Counting rings in scales is only acceptable for aging relatively young

Table 2. Growth of subadult red drum in South Carolina's estuaries. Results are for "average fish" born in 1986.

Month	Year	Number of rings on scales or otoliths	Age in months	Length in inches	Weight in lb- oz
August	1986	0	Birth		
September	1986	0	1	1/2	1/100 oz
September	1987	0	13	12-3/4	0 lb 12-1/4 oz
September	1988	1	25	21-1/2	3 lb 7 oz
September	1989	2	37	27	6 lb 11 oz
September	1990	3	49	31	10 lb 7 oz

fish because in larger, older fish, scales become thick and annual rings are difficult to see. I prefer to use rings in one of the earbones (otoliths in the jargon of fisheries scientists) called the sagitta to age red drum because in this structure the rings are very distinct and easy to count.

If for example, biologists want to determine the age of a 20 pound red drum caught during a fishing tournament, the following procedure is used. The length and weight of

the fish are measured, and the largest pair of earbones is removed from the skull, cleaned and taken to the laboratory. There, two cross-sections of one of the earbones are made through the center with a jewelers saw. The section is then viewed under a microscope and the rings counted (Figure 7).

By examining sections of the earbones taken from red drum of various sizes each month throughout the year, it was shown that (1) juvenile red drum do not deposit a

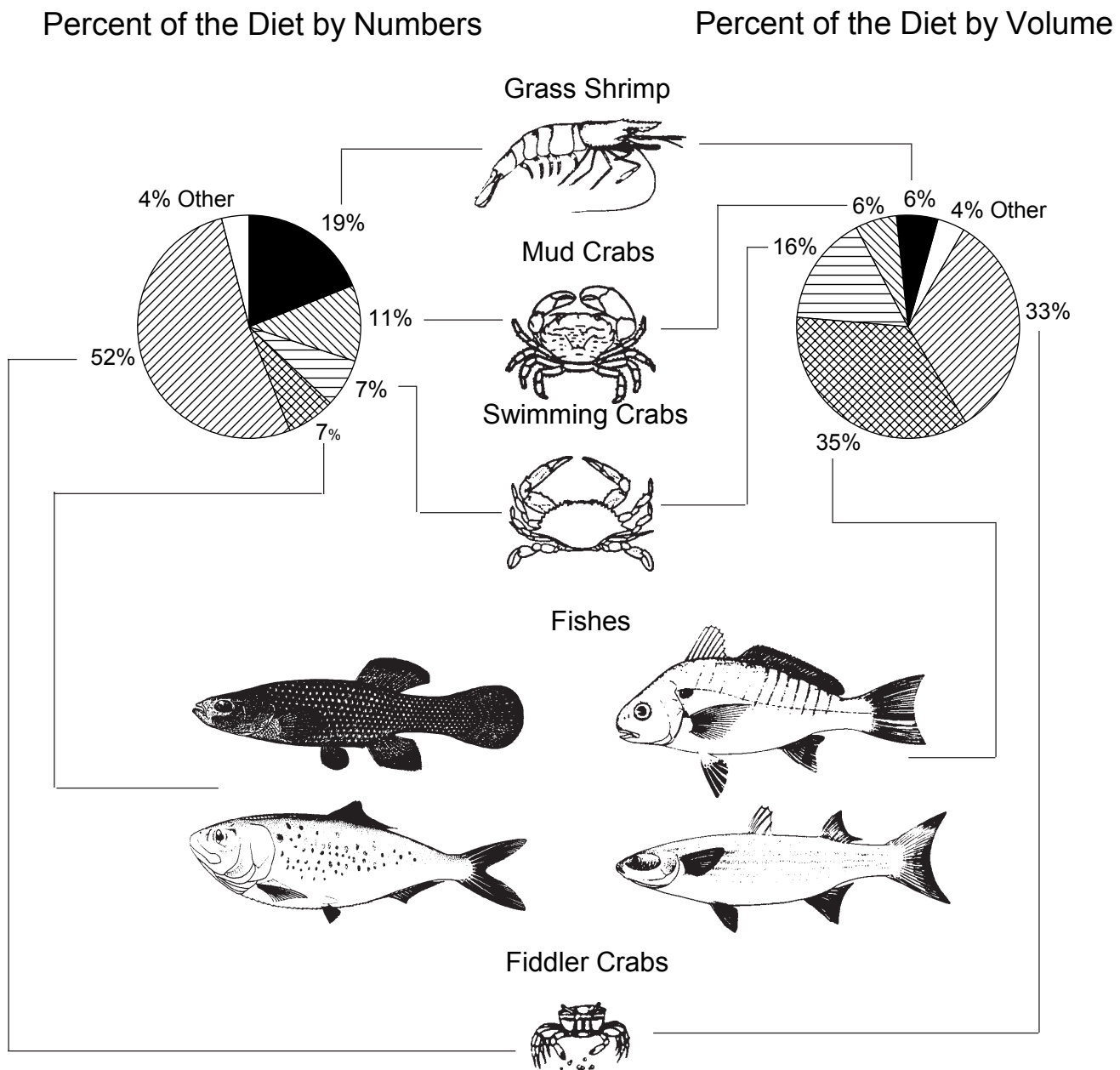

Figure 6. Food of subadult red drum - 7 to 21 inches in total length.

ring after the first winter when they are about seven months old; (2) older fish form one ring a year on the earbones in April and early May. If you captured a red drum in May 1990, that had one ring near the edge of its otolith, the fish would be about 21 months old and was spawned in late summer of 1988. By convention, fisheries scientists would refer to that fish as a member of the 1988 year class.

Figures 8 and 9 summarize growth information for red drum during their juvenile and subadult phases based on measurements of ear bones and length information. These figures represent the “typical fish”, that is, the points are average values of

length and weight of several red drum at each age. The information in these figures can then be used to estimate the age or weight of a red drum based on only a length measurement.

ADULTS

The adult phase of the life of the red drum begins when the fish mature and can spawn. At this point in the life cycle, red drum move from the estuaries and join the breeding population inhabiting the coastal ocean off South Carolina. It is rare event for an angler to catch a trophy red drum larger than 15 pounds inside the estuary.

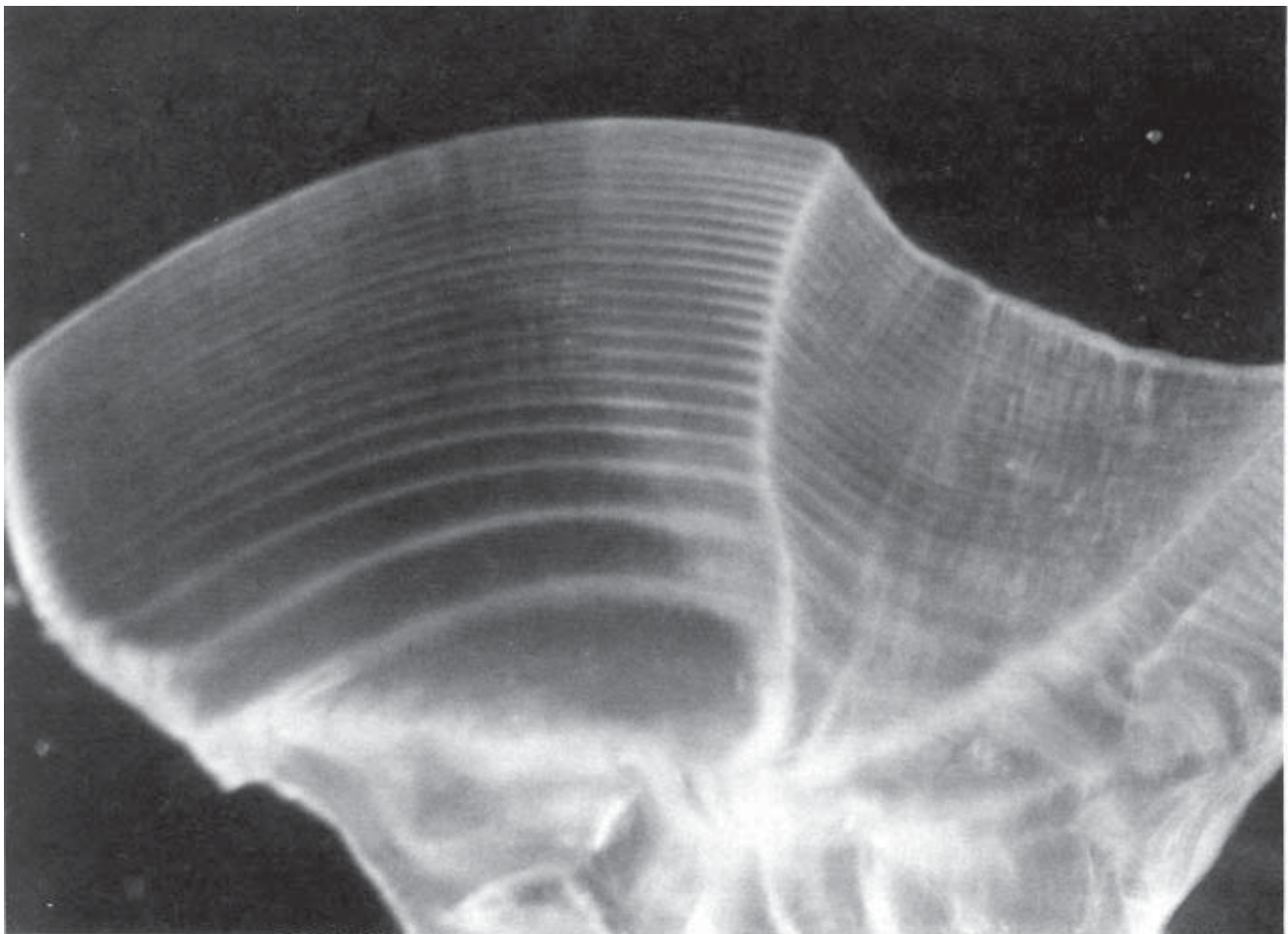

Figure 7. Photograph of a cross-section of a red drum otolith showing rings.

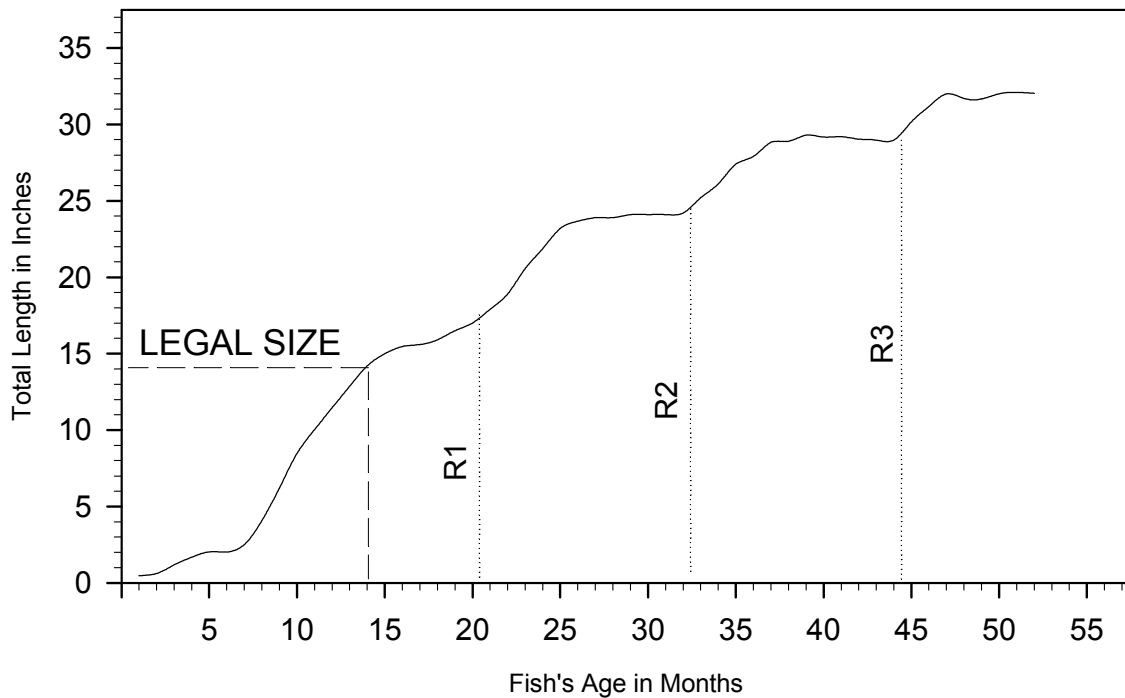

Figure 8. Changes in length of subadult red drum with age. Points represent average values of length at an age. The dashed line shows the minimum legal size of 14 inches; on average, a 14 inch red drum is about 14 months old. R1, R2, and R3 are ages of red drum when they have deposited 1, 2, or 3 rings on their earbones and/or scales. A fish that just formed one ring is 16 inches long, with 2 rings about 24 inches long, and with 3 rings about 29 inches long.

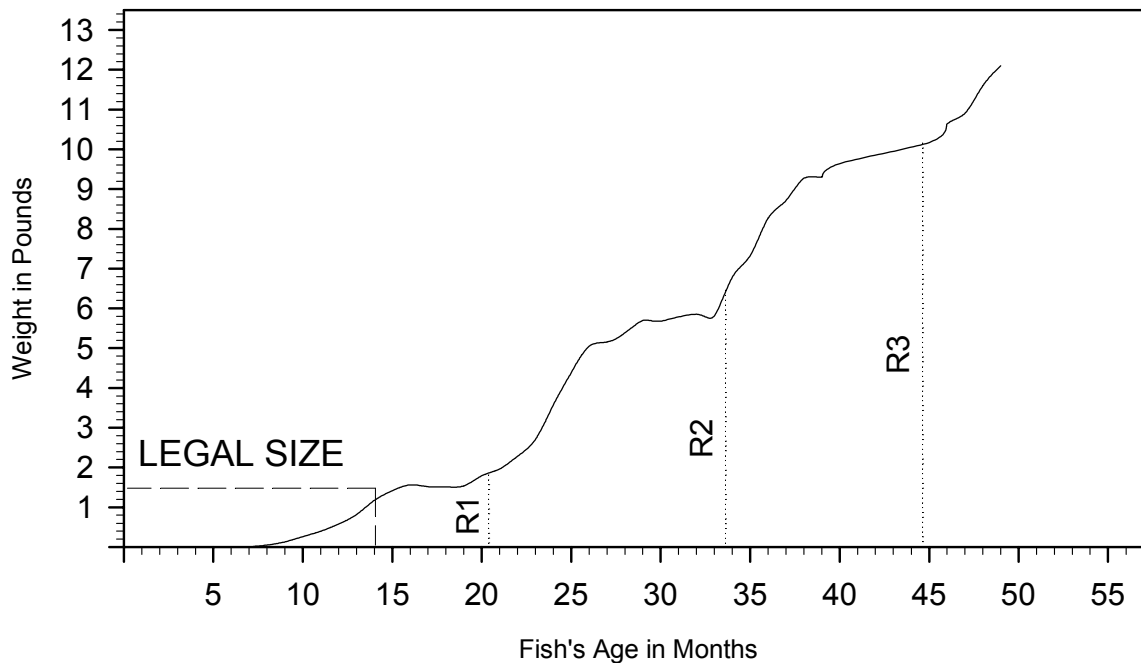

Figure 9. Changes in weight of subadult red drum with age. Points represent average values of weight at an age. The dashed lines show that on average a red drum of 14 inches in length, the minimum legal size, is about 14 months old and weighs about 1 pound. R1, R2, and R3 are the ages of red drum when they have deposited 1, 2, or 3 rings on their earbones and/or scales. A fish that just formed one ring weighs about $1\frac{1}{2}$ pounds, 2 rings about $4\frac{3}{4}$ pounds, and 3 rings about $8\frac{1}{2}$ pounds.

Studies in South Carolina have found that male red drum less than 22 inches in total length are immature. Males this size are between two and three years of age. By age 4 when male red drum are about 28 inches long, all males are mature. On average, a male born in 1991 spawns in 1995. Females are older and larger than males when they reach maturity. In South Carolina, females do not spawn until they are 33 inches long or about five years old. In other words, the “average” female red drum born in 1991 does not spawn until 1996.

In coastal South Carolina, the exact locations where red drum spawn and the size of the spawning population are unknown. Neither spawning fish nor recently fertilized eggs have been collected in our waters. However, the smallest larvae (about one-tenth of an inch in length) are caught in fine mesh nets near inlets, red drum probably spawn in the coastal waters, in the vicinity of inlets. In the northeastern Gulf of Mexico off the Louisiana, Mississippi, and Alabama coasts, red drum spawn about 12 miles from the mainland in water depths ranging from 30 to 60 feet.

Many fishes use predictable changes in their environment as cues for timing reproductive activity. This ensures that spawning coincides with environmental conditions that are favorable for the survival of young. The most important environmental factors affecting reproduction of red drum as well as many other fishes are water temperature and the amount of daylight (photoperiod in the jargon of fisheries scientists). Therefore, as days begin to get shorter and South Carolina’s coastal waters begin to cool in mid to late August, adult red drum begin their reproductive activity. Because one month old red drum are more abundant in nursery areas during October, the most intense spawning activities seem to occur in September.

Although spawning red drum have not been observed in nature, intensive studies

have been carried out in the laboratory. Researchers from the Marine Division of the South Carolina Wildlife and Marine Resources Department obtained adult red drum both from recreational anglers and their own sampling activities and held them in tanks. By controlling the water temperatures and regulating the amount of light, these red drum were induced to spawn. Table 3 summarizes the environmental conditions used to induce spawning of red drum. The process used compresses the four seasons into seven months. Red drum have been kept in spawning conditions for as long as three months and during this period, thirty adult red drum (8 females, 22 males) produced an estimated 60 million fertilized eggs.

Male red drum produce a “drumlike” sound and stay close to the females in laboratory tanks when it is time to spawn. In addition, they change color becoming dark red or bluish gray above and pale white on their belly. The males nudge the females in the belly with their head during courtship. Contractions of the muscles adjacent to the swim bladder cause it to vibrate and produce the drumming sound. Members of the family of fishes to which red drum belong have the ability to produce “drum-like” sounds, hence the name “drum” family.

In the laboratory, spawning begins around dusk when females discharge ripe eggs into the water and the males release sperm. The eggs that are successfully fertilized, float to the surface, unfertilized eggs sink. Red drum eggs are about 0.04 inches in diameter (you would have to line up 25 eggs in a row to cover a distance of one inch; 625 fertilized eggs would fit into a one inch square). Immediately after fertilization, the red drum embryo begins to develop inside the egg. Hatching occurs in 28 to 29 hours when water is maintained at 72 degrees Fahrenheit. Hatching takes slightly longer in cooler water and slightly shorter in warmer water.

At hatching, the small larvae are 0.07

Table 3. Schedule of holding conditions for laboratory spawning of red drum used by the Marine Resources Research Institute of the South Carolina Wildlife and Marine Resources Department.

Season	Hours of Light	Water Temperature	Number of Days Held	Dates
Fall	11	70	14	Sept 24 - Oct 7
	11	66	14	Oct 8 - Oct 21
	10	63	14	Oct 22 - Nov 4
Winter	9	59	14	Nov 5 - Nov 18
	9	55	24	Nov 19 - Dec 11
	9	59	7	Dec 12 - Dec 19
Spring	10	63	14	Dec 20 - Jan 2
	11	68	14	Jan 3 - Jan 16
	12	73	14	Jan 17 - Jan 30
	13	77	14	Jan 31 - Feb 13
Summer	13	81	14	Feb 14 - Feb 27
	14	82	14	Feb 28 - Mar 13
	14	84	24	Mar 14 - Apr 7
	14	82	14	Apr 8 - Apr 21
Late Summer	13*	81	14	Apr 22 - May 5
-early fall	12*	77		May 6

* = when spawning generally begins.

inches in length. Their mouth is not yet formed and as a result they cannot feed. These small larvae rely upon yolk remaining from the egg as their food source (see Figure 10). Three days after hatching, the mouth, stomach, liver and intestines are well formed. The food reserves in the egg (the yolk that was on the belly of the larva) are used up and the larvae begin to feed on small planktonic animals in the water.

A particularly critical point in the life cycle of the red drum is the movement of the developing young from the coastal waters into the nursery habitat. Anyone who has spent time fishing in South Carolina estuaries is familiar with the strong currents that move both upstream and downstream with each tide. The question arises as to how do the young red drum which are poor swimmers reach nursery grounds that are fre-

quently 20 or more miles upriver from the ocean when these strong currents could sweep them out to sea.

Although scientists have not specifically studied how red drum do this, they have examined other species of fish and shrimp that spawn offshore and use the upper reaches of the estuary as a nursery area. When the tide begins to flood, young of these species move towards the surface and ride the tidal currents into the estuary. Generally, they move closer to the surface at night than during daytime flood tides. In waters near the coast and around inlets, turbidity increases with depth, that is, the deeper you go, the muddier the water gets because of the settlement of particles of silt and other materials suspended in the water. The larvae avoid the clear surface water during the day because there they would be more visible to

Late stage egg = 24-29 hours after fertilization
diameter of egg = about 0.04 inches

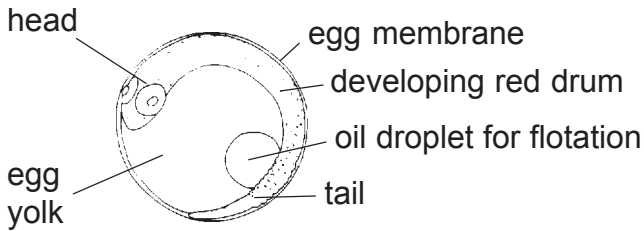

Larvae one hour after hatching:
total length = about 0.07 inches

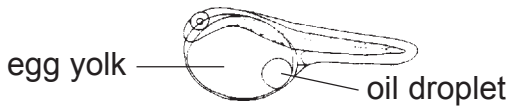

Larvae 36 hours after hatching:
total length = 0.07 inches



Four day old larvae: length = 0.11 inches



Eight day old larvae: length = 0.15 inches



Thirteen day old larvae: length = 1/4 inch



Figure 10. Fertilized eggs and development of larval red drum.

predators. However, they move nearer the surface at night because in the dark they can't be seen. When water begins to move from the estuary to the ocean with the ebb tide, the larvae sink to depths close to the bottom. As you go from surface to bottom, the strength of the tidal currents decreases (Figure 11). The result is that the larvae are gradually transported up-estuary and finally enter the shallow creeks. Once in these nursery creeks, the larvae settle to the bottom and begin to take on characteristics of juveniles.

Successful spawning of red drum does not necessarily translate into large number of juveniles. Of the millions to billions of eggs that are spawned only a small proportion survive to reach the nursery grounds. Environmental factors affecting the number of red drum larvae that enter our estuaries are not known. However, scientists have shown in other species with similar life history patterns that the frequency and direction of winds can affect the number of larvae that enter estuaries. In addition, relatively few of the larvae that reach the nursery ground will survive the first winter, especially if water temperature declines below 40°F during winter cold snaps. Less than 1% of the eggs of ocean spawners like red drum survive to become juveniles. Once red drum reach about four inches or 7 to 8 months of age, mortality rates due to natural environmental factors decline to a relatively low level.

After red drum reach sexual maturity and join the spawning population found in coastal waters, they grow very slowly. In 1988, when I first looked at a thin slice taken through the center of an earbone from a 30 pound red drum under a microscope, I was very surprised. The fish had 23 rings which meant that it was about 25 years old and was spawned sometime around September 1963. My previous experience was with the fast growing subadult red drum found inside South Carolina's estuaries which, on

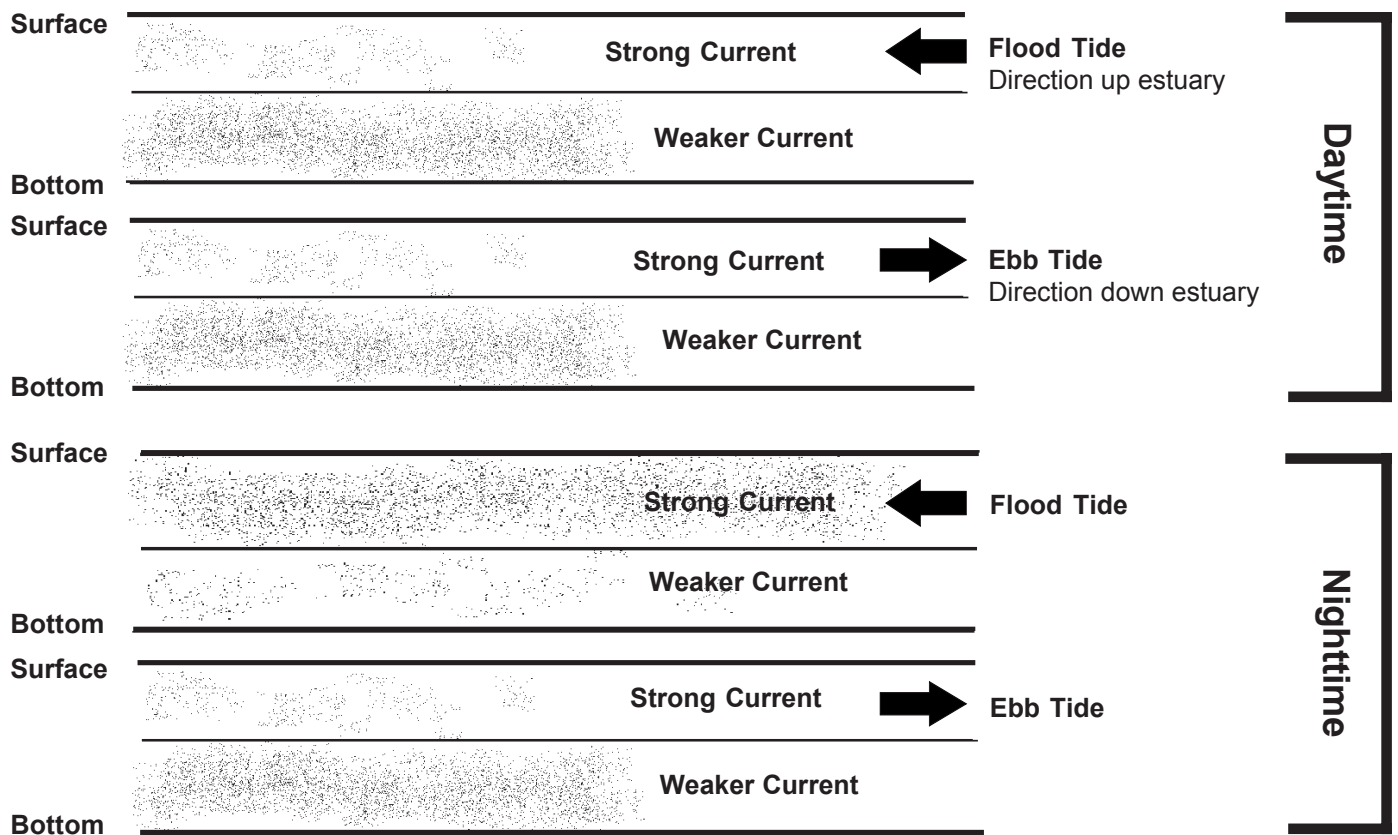

Figure 11. Surface - bottom currents and clarity.

average, attain a length of 31 inches and a weight of 11 to 12 pounds in four years. After more of the large adult fish were examined, the same pattern was consistently seen. Biologists studying red drum in North Carolina and Georgia have also shown that red drum have a long life span and once that they attain sexual maturity, the growth rate slows. Figure 12 shows the change in length with age for red drum in South Carolina and Figure 13 presents the change in weight that occurs with age. From Figure 13, it is apparent that weight is more variable than length at a given age. This is because the weight of an individual red drum depends on the season when it is caught. If a red drum is caught in September, it will probably weigh less at a given length than the same size fish would weigh in November. This is because in late September red drum have just finished spawning, a process which takes a great deal of energy (you can say that during the period from August to mid-September

the adult red drum have more on their minds than food). When a fisherman catches a trophy red drum (>30 lbs), he or she is catching an old fish, that in many instances may be older than the angler. Figure 14 gives a graph from which the weight of a fish can be estimated from the length.

The foods of the large subadult and adult red drum are mainly fishes and crabs (Figure 15). Fishes are about one-half of the food items eaten and make up over three-quarters of the total volume, Atlantic menhaden and spot are the preferred food. Very few mud minnows and striped mullet are eaten. This makes sense because mud minnows and striped mullet are mainly found in shallow water around marshes whereas spot and Atlantic menhaden are abundant in coastal waters where large fish are found. Swimming crabs (these are crabs whose back legs are flattened and act as paddles) such as the speckled crab or blue crabs, are the predominant crabs eaten by adult red drum.

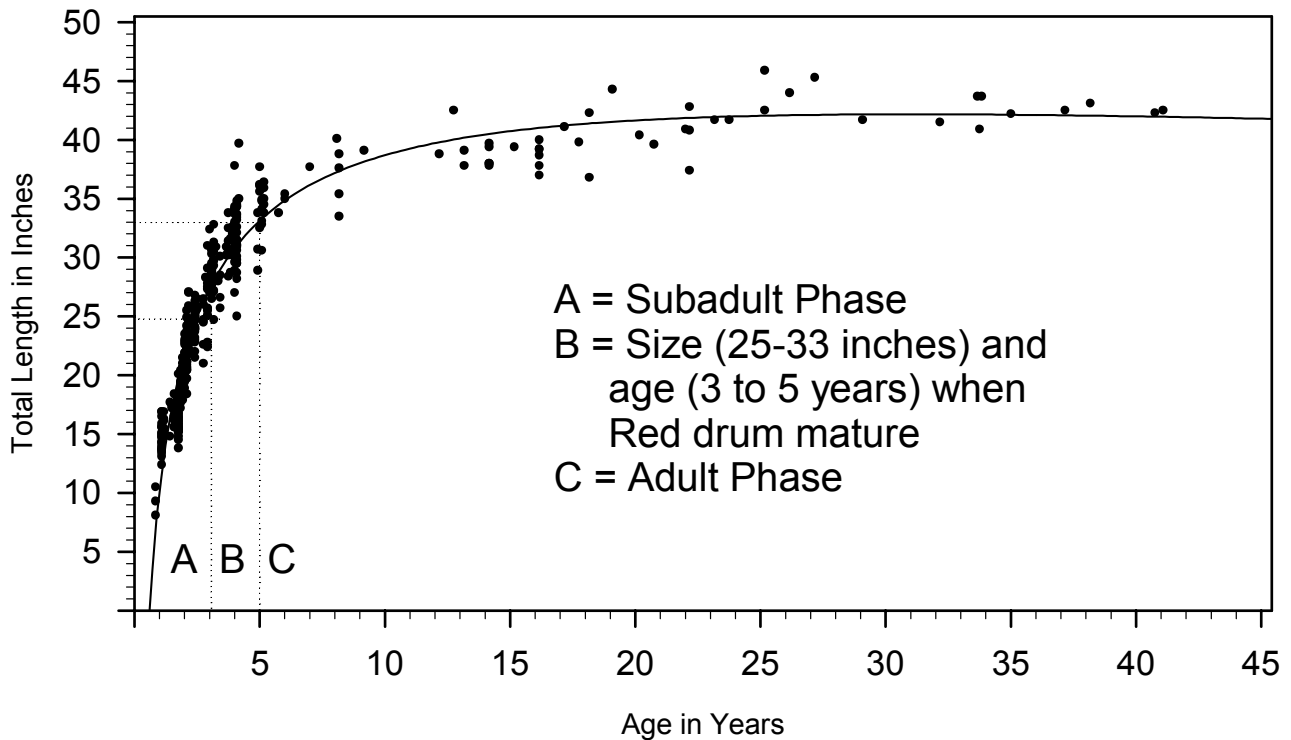

Figure 12. Growth of red drum in South Carolina; solid line describes trend in length with increasing age; dots represent individual fish. A = subadult phase - red drum in this phase are generally inside estuaries; B is the size range (from about 25 to 34 inches total length) and the age range (3 to 5 years) when red drum become mature and leave the estuaries to join the spawning population in coastal waters; C = adult phase.

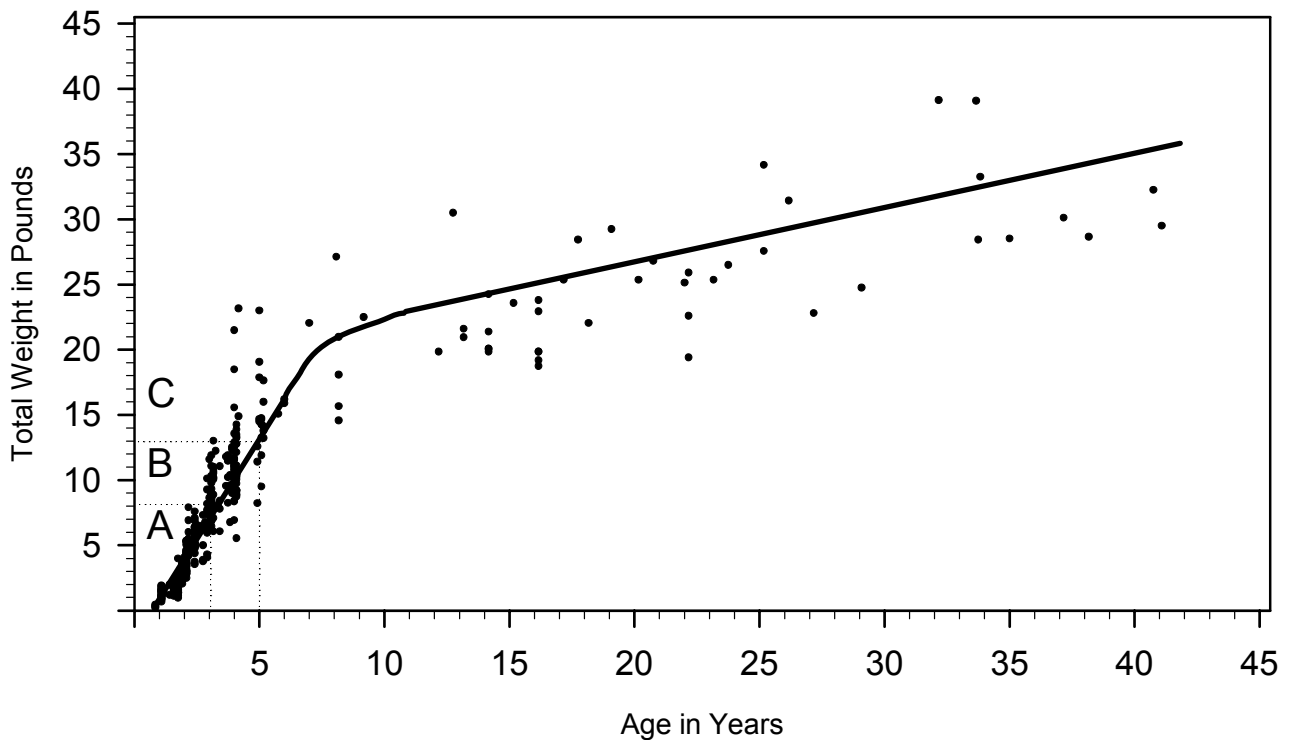

Figure 13. Growth of red drum; solid line describes trend in weight with increasing age; dots represent individual fish. A is the subadult phase - red drum in this phase are generally in the estuaries; B is the size range (from about 8 to 13 pounds) and the age range (3 to 5 years) when red drum become mature and leave the estuaries to join the spawning population in coastal waters; C is the adult phase.

If I had to choose a bait for large red drum based on these findings, I would pick live menhaden and chunks of blue crab.

TAGGING STUDIES

Marks or tags have been used to identify fishes in the wild for over 300 years. Izaak Walton wrote in *The Compleat Angler* in 1653 that private citizens tied ribbons to the tails of juvenile Atlantic salmon. The juveniles left the streams and went out to sea where they fed and grew. When the salmon reached sexual maturity, they returned to the streams where they spawned. It was shown by the return of tagged individuals that the Atlantic salmon returned to their birth place to spawn. In the United States, the tagging of fishes first began in 1873 when Atlantic salmon were tagged and released in Maine's rivers. Since that first experiment over 120 years ago, fishery biologists have tagged and released many types of

fishes (large and small; young and old; fresh-water and saltwater; in streams, rivers, lakes, estuaries and oceans) to study their habits. Tagging studies have many purposes including:

- ❖ investigation of movements and migration,
- ❖ estimation of growth rates in the wild,
- ❖ determining the degree to which fish from different regions intermingle during reproduction and other critical periods,
- ❖ estimating abundance,
- ❖ estimating the proportion of fish being taken by fishermen.

Each of these uses are briefly discussed below.

Personnel in the Marine Division of the South Carolina Wildlife and Marine Resources Department are presently using several types of tags (Figure 16). On our project, we use internal anchor tags to mark red drum from 10 to 22 inches in total length

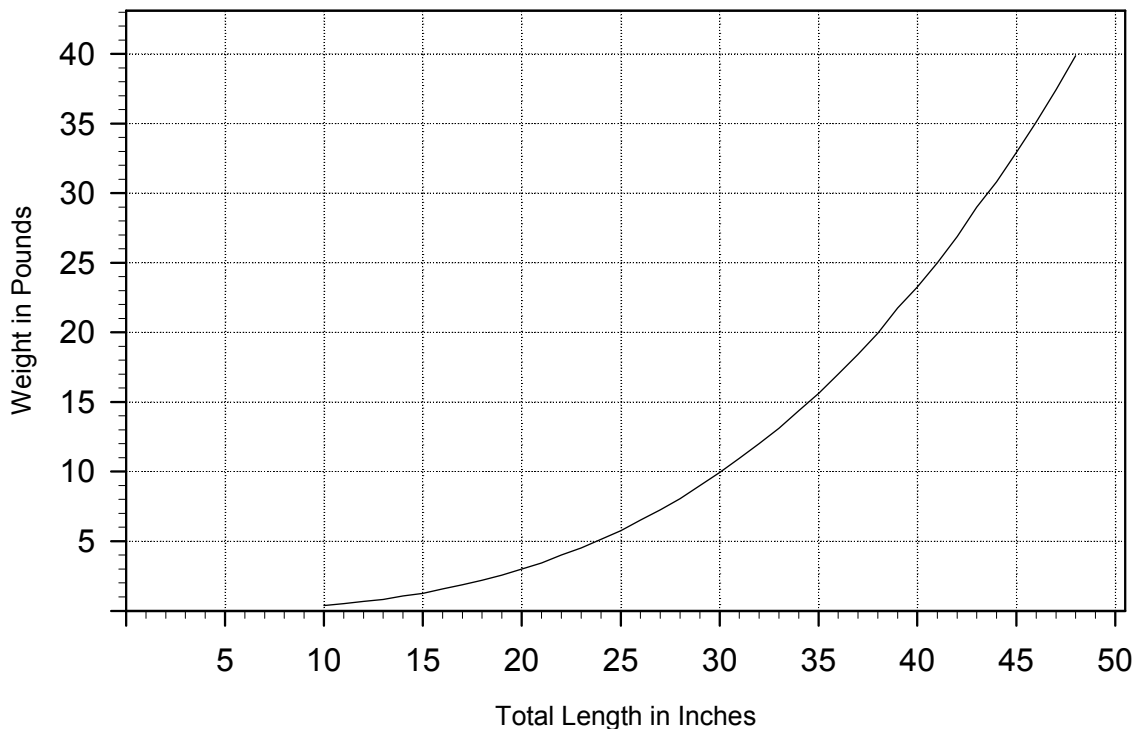

Figure 14. Weight in pounds of red drum at a given total length. Curve represents the average fish. To estimate weight go along bottom to value, say 30 inches, go to curve, and then read value of weight off left scale; for 30 inch red drum weight is about 10 pounds.

Percent of the Diet by Numbers

Percent of the Diet by Volume

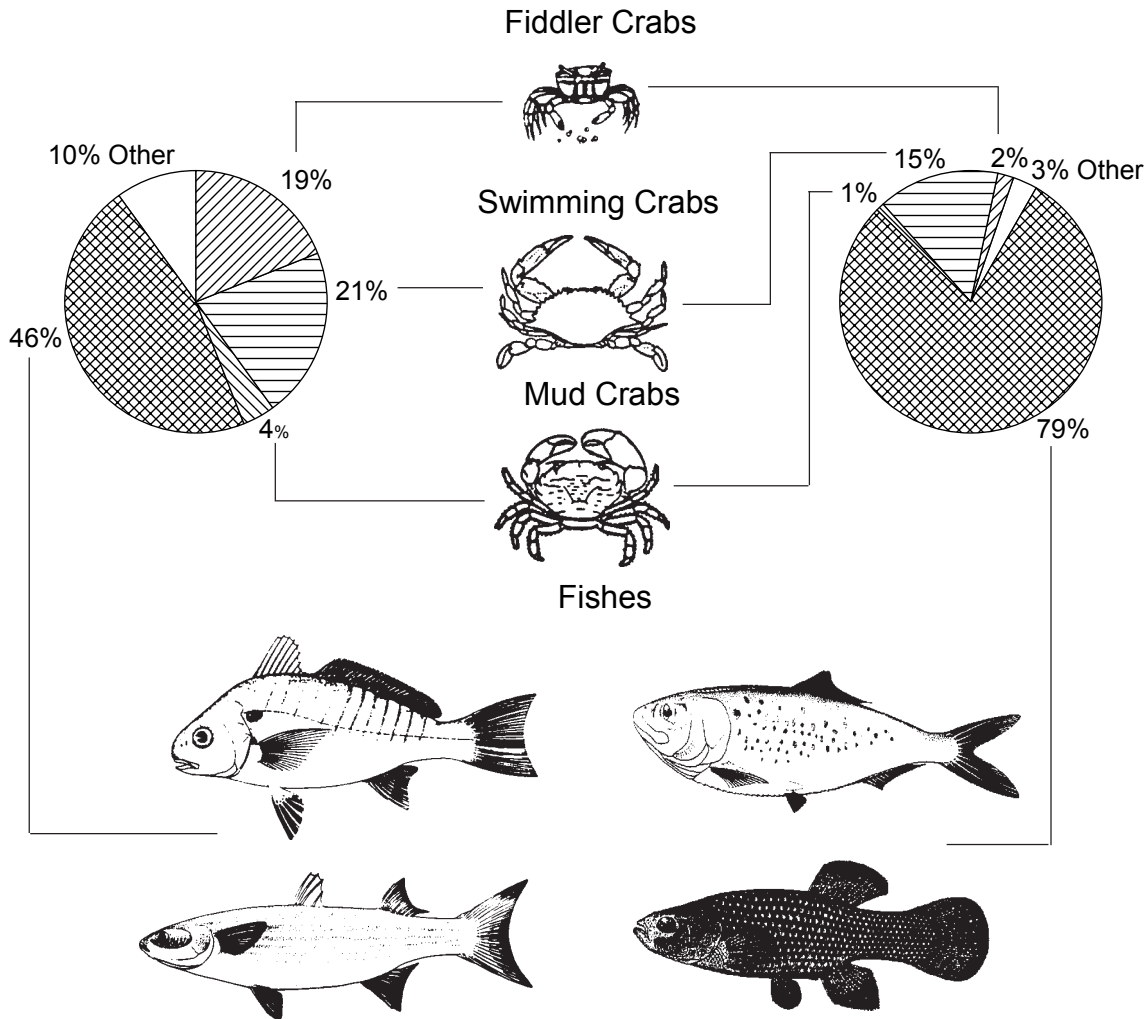

Figure 15. Food of red drum that are 21 inches total length and larger.

and dart tags for larger fishes. Each tag has a serial number printed on it as well as instructions on how to forward the information about the captured fish to the Wildlife Department. The angler who cooperates with the study will receive a letter detailing the history of the captured fish as well as a reward for his or her trouble.

Our project has tagged and released 7,147 red drum in South Carolina's estuaries and coastal waters. To date anglers have returned tags from 1,438 fish which represents 20.1% of the total number that were

tagged and released. These data furnished by anglers showed that a high percentage of red drum were caught shortly after they were tagged (see Figure 17). Almost 18% were caught within 20 days of release, and 66% were taken within six months of tagging. The longest time that a tagged red drum has been at large was 3 years 8 months. Over 38% of the tagged red drum were caught within 1 mile of where they were tagged and released: 72% were caught less than 5 miles from the release point (see Figure 18). About 15% of the tagged fish

moved more than 10 nautical miles and only 5% travelled 50 nautical miles or more. Most (45 of 57) of the tagged red drum that moved more than 50 miles went north and in general the long distance movers were fish less than 18 inches in length. The longest reported distance was for an 18 inch total length fish that was tagged and released in Bulls Bay and was caught 189 days later at a size of 22 inches in Mantanzas Inlet, Florida. This individual moved 234 nautical miles. The farthest north a red drum has moved is 159 nautical miles from Charleston Harbor to above Cape Fear (see Figure 19). By looking at the distance moved and the days at large, the rate of movement can be estimated. Movement rates calculated in this way are rough guesses because it is not known whether the fish swam directly between the two points or if the animal stopped

along the coast to feed and rest. The two fastest moving red drum averaged 3.7 miles per day. One fish, 12 1/2 inches in length, moved from Charleston Harbor to North Myrtle Beach (86 miles) in 23 days; the other, 13 inches in length, covered the 73.5 miles between Bulls Bay and Cherry Grove in 20 days. Most of the fish that moved longer distances were less than 18 inches long.

In the general description of tagging, I mentioned that data from these studies could be used to measure the growth of fishes in the wild. For example, during the course of our red drum studies, we have recaptured, re-released, and recaptured several hundred fish. Each time they are captured, the fish are measured and the increase in size is determined. In July 1988, we tagged a red drum born August/September 1987 that has

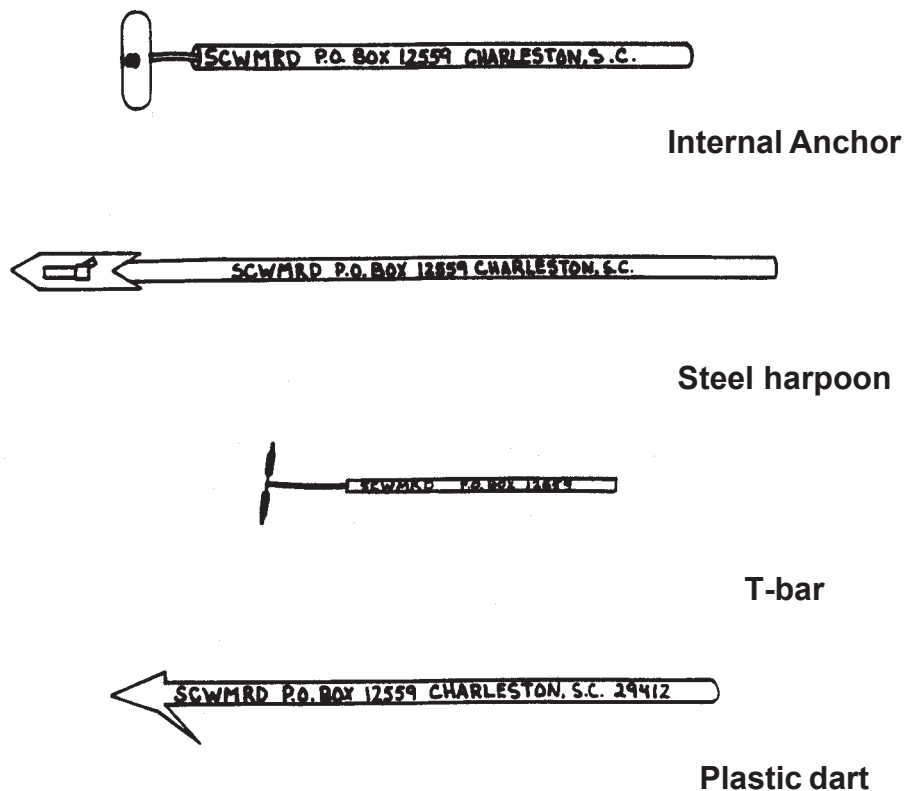

Figure 16. Photograph of the different types of tags used by South Carolina Wildlife and Marine Resources Department - Marine Resources Division.

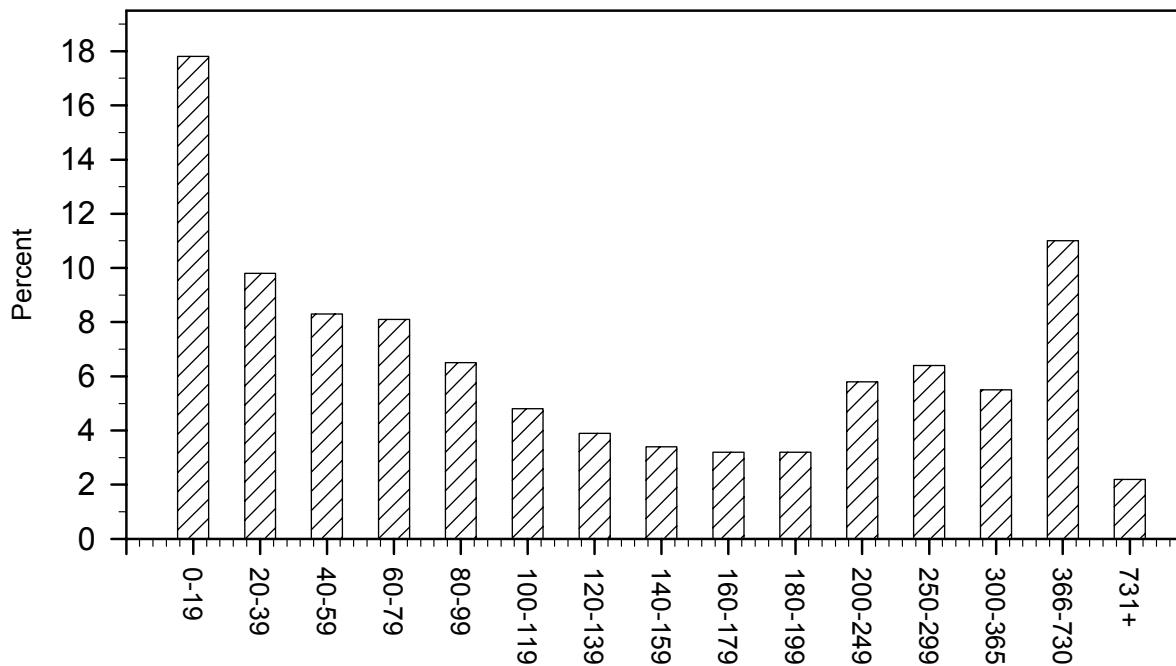

Figure 17. Breakdown of the days at large for 1,546 tagged red drum caught by recreational fishermen; almost 18% were harvested in less than 20 days; 66% were caught in less than 6 month; about 13% were at large for more than 1 year and of these 21 individuals were taken after 2 years. The longest period at large for a red drum to date is 3 years 8 months (1355 days).

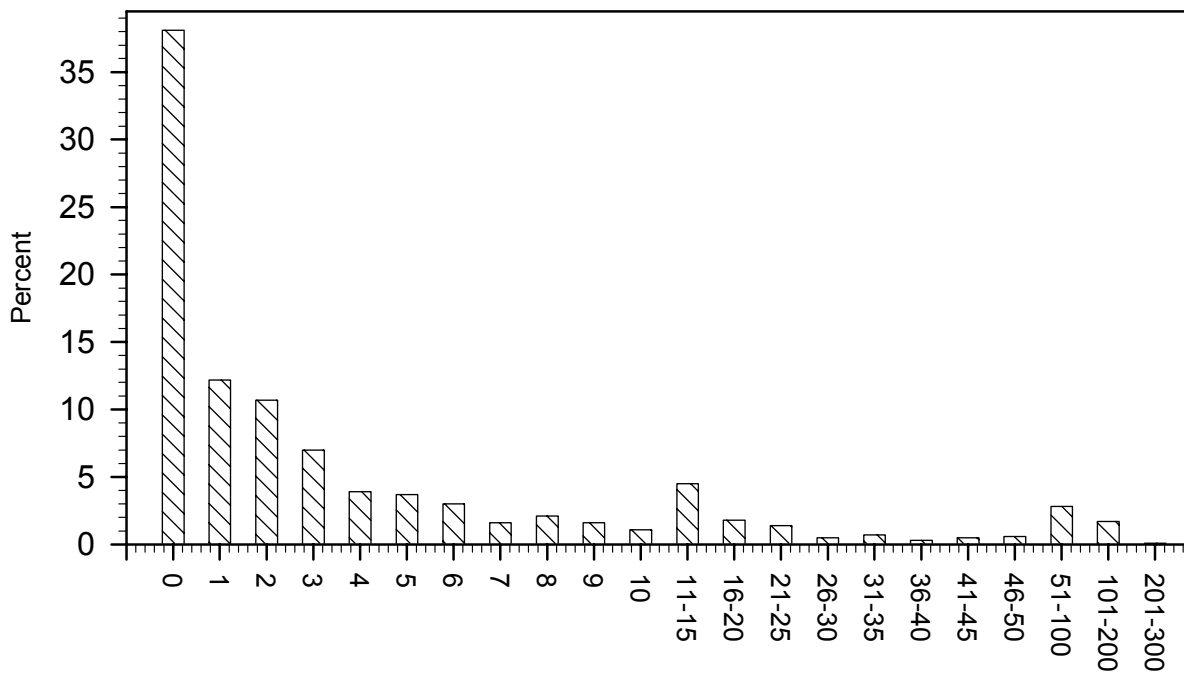

Figure 18. Breakdown of the distance moved from the tagging location and where the red drum were harvested. When distance is 0, fishes were caught where they were tagged and released. One nautical mile = 1.15 statute miles or 6, 080 feet.

subsequently been recaptured and re-released five times as follows:

Date	Total Length (Inches)	Age (Months)	Comments	Growth (Inches/month)
07/27/88	10.1	11	initially tagged	
10/24/88	14.1	14	recapture 1	1.00
12/20/88	14.4	16	recapture 2	0.15
09/14/89	19.8	25	recapture 3	0.55
10/13/89	20.4	26	recapture 4	0.60
12/13/89	21.1	28	recapture 5	0.35

Tags from 19.2% of the 4,400 red drum that were marked have been returned by anglers. This however, does not mean that the harvest rate is 19%. It is actually much higher than 19% because when tag return data are used to estimate harvest rate, many factors need to be taken into account. First, an estimate of tagging mortality (that is the percentage of the fishes that die as a result of capture, tagging, and handling) is needed. Because red drum is a hardy species that tolerates the stresses associated with tagging and all the fish we tagged were in good shape, very few of the 4,400 fish we tagged died from tagging. Second, information on the shedding rate (that is the percentage of tags inserted into red drum that are lost) is required. Biologists in Texas have captured red drum, marked them with internal anchor tags that are similar to those used in South Carolina, and held in ponds for twenty months. They found that about 9% of the tags that were inserted were lost. Both handling mortality and loss of tags reduces the number of tagged fish in the wild and, hence, there are fewer marked fish available to anglers. The estimate of 9% is probably a good approximation of the percentage of tagged fish that lost their tags. Observations on recaptured red drum have shown that the main reason for tag loss results from the cutting off of the streamer of the internal anchor tag at the body. This would result in either a very small nub sticking out through

the abdomen or a small scar where the tag had been inserted. In either case, a fisherman who catches such a fish could very easily overlook the scar or the very small remaining portion of the tag.

The third and most important factor is the amount of cooperation shown by the public with the agency responsible for monitoring tagging information (this is the percentage of the tags removed from marked red drum harvested by fisherman that is reported). No information is available on the level of cooperation of anglers in South Carolina, but in Texas, only one-third of the tagged fishes caught by anglers was reported to Texas Parks and Wildlife. In Georgia, approximately 50% of the tagged fish are reported. As far as the estimates of the level of cooperation of the angling public in returning tags removed from harvested red drum are concerned, the information for our state is simply not available. I sincerely hope that South Carolina anglers are more cooperative than Texas fisherman who failed to report two - thirds of the tags they encountered.

If you assume that (1) no tags are shed and (2) all tags removed by anglers from harvested red drum are reported to the South Carolina Wildlife and Marine Resources Department, the overall harvest rate is 19.2%. However, adjustments for tagging loss rate and angler reporting efficiency can have a large effect on estimates of harvest rates as shown in the example below.

Number Tagged	Percent Tag Loss	Adjusted Number	Reported Captures	Percent Reported	Adjusted Recapture	Percent Harvested
4,400	0	4,400	843	100	843	19.2
4,400	0	4,400	843	50	1,686	38.3
4,400	0	4,400	843	33	2,555	58.1
4,400	9	4,004	843	100	843	21.1
4,400	9	4,004	843	50	1,686	42.1
4,400	9	4,004	843	33	2,555	63.8

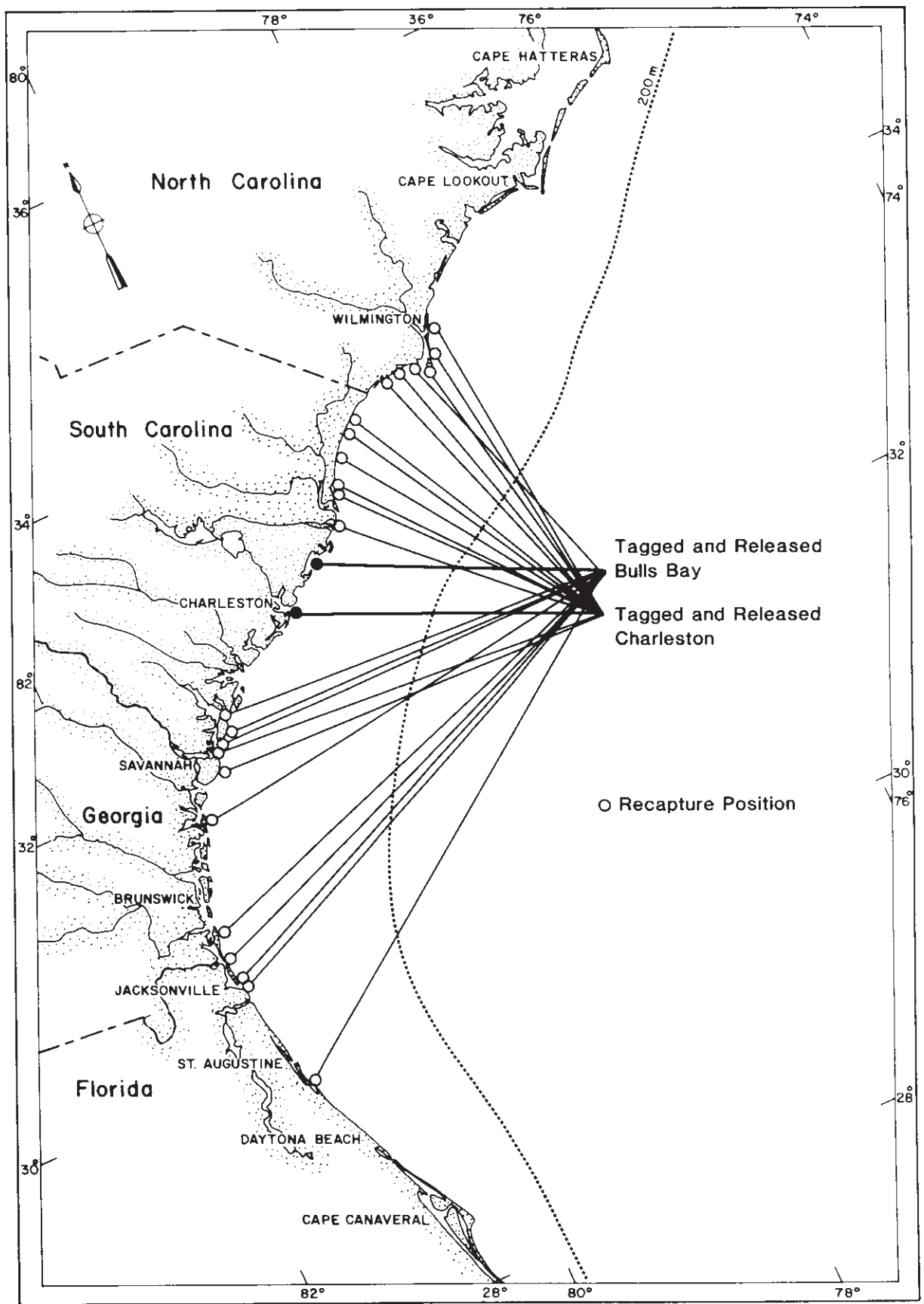

Figure 19. Some long distance movements of tagged red drum. Some recapture positions represent more than 1 recapture.

In the worst case, a 9% tag loss and a 33% reporting rate result in 63.8% of the sub-adult red drum being harvested. Also, this does not take into account those that die from “natural” causes such as disease, winter freezes, or predation. When you consider that most of the red drum we tag are 1-3 years old, these data suggest that few reach maturity and spawn and provide more bass for the future.

FISHING TECHNIQUES

Surf Fishing

In South Carolina, most red drum are caught by anglers fishing from boats in the tidal creeks, bays, sounds and inlets along the coast. However, in my estimation, there is no finer way to engage in combat with a red drum than by hanging a good fish in the surf on a deserted stretch of beach on a Carolina barrier island.

I began to fish the surf in earnest in the early 1970's while attending graduate school in Marine Science at the College of William and Mary in Virginia. My proudest possession was one of the old style four-wheel drive Ford Broncos (the one that looked like a box on wheels) that had rod holders on the front bumper and a roof rack on top. My six 11 to 13 foot long surf rods with their reels were cradled on the sides of the roof rack.

The truck was completely dedicated to running the then almost deserted beaches of the Outer Banks of North Carolina in pursuit of bluefish and red drum. At this time in my life, I was completely addicted to the sport of surf fishing and have many good memories of time spent on the Outer Banks. The people, places, dates, and catches make a collage in my mind.

The timing of my trips to the Outer Banks coincided with the movement of trophy-size red drum into the surf at Cape Hatteras in the spring (April-May) and fall (October-November). My ability to success-

fully fish the surf improved with time and I caught a number of red drum that weighed over 40 pounds with the largest exceeding the capacity of a 55 pound scale.

During the early trips, some of these big fish were killed. I bragged about them, photographed them, weighed them in so I would receive a North Carolina Tournament Certificate, and ate them. Five certificates for red drum that ranged in weight from 46 to 49 pounds are either stuck away in drawers or hung from the walls of my office. The fish I killed were old (probably 20 to 40 years of age), large members of the spawning population, a fact that was unknown to me at that time. In retrospect, the certificates were nice, but I wish I had set those fish free.

I'd like to share with you one of the very pleasant memories of my fishing career on the Banks. I don't fish there anymore because big red drum are available on South Carolina's barrier island beaches without the crowds of fishermen in North Carolina.

On a Wednesday in late October, the area around the lighthouse at Buxton on Hatteras Island was crowded with anglers fishing for large red drum. Crowds make me nervous, so after loading sandspikes, rods, etc., in the truck, I left to find a less congested fishing spot. Since Hatteras Inlet was also mobbed, I took the ferry at Hatteras Village to Orcacoke Island.

While driving down the beach at late ebb tide, I scanned the surf looking for a cut through the off-shore sand bar with an area of deeper water called a slough on the Banks. Upon finding one of these cuts, I would record the distance from the hole to a reference point, usually the access ramp which crossed the dunes to the beach. After going down the beach another one to two tenths of a mile, a driftwood stake would be driven into the beach above the high tide mark. At night, if someone used the stakes as a fishing location, they would not be where I wanted to be, but down the beach a

distance great enough so as to not bother me.

The truck was parked above the high tide mark, and preparations were made to fish that night's incoming tide. The Coleman stove came out and a pot of coffee was rustled up. The evening's menu consisted of extra chunky peanut butter and grape jelly on white bread (it's easy to remember what I ate that night because that was standard fare), and since the bait knife was the easiest to get to, the sandwich had a faint taste of mullet. Three rods were placed in sandspikes spaced about ten yards apart near the water's edge, and the bait box was removed from a cooler.

To store cut bait, mainly mullet, I like to use rectangular shaped Tupperware containers that are used to store bread. I line the bottom with a layer of salt and put a layer of scaled fillets with the skin attached from one to three pound mullet. Layers of mullet and salt are alternated. The salt toughens the bait so that small fishes do not pull the bait off.

The wind was light and the surf moderate. A four-ounce pyramid sinker probably would have held the baits in place, but six ounce sinkers were used. Since I planned to fish three rods, if a bait broke free and was pulled along the bottom by the longshore current that ran down the slough, I would have a mess on my hands trying to untangle three lines in the dark.

Three chunks of bait were threaded on the 9/0 hooks, and the rigs were cast into the slough. One was thrown out as far as I could heave it. The second went out a medium distance, and the third was cast short, close to the beach. I set the drags on the three rods with light tension, seated myself in a lawn chair, and waited for what the tide would bring.

The next few hours were spent freshening baits, checking drags, and drinking coffee. The tide would be high at 2 a.m. and the night was clear with shining stars. There wasn't another soul on the beach, and

it was one of those times when your head fills with all kinds of deep thoughts. Sometime around midnight, I dozed for a few seconds, and woke with a start. False alarm—nothing was happening. My reaction was one of those reflexes that all of us have had when we doze off at locations when we're not supposed to (like in church or school). I rechecked the baits, and settled back down in the lawnchair with a hot cup of coffee. The rod that was cast out farthest in the slough bent and the drag screamed. I grabbed the rod and tightened the loose drag. The force on the rod and the rate of disappearance of the line from the spool indicated that there was a large fish attached.

Excitedly, I hung on as the fish pulled out more line when a thought entered my mind - "What if a school swam into the slough?" Two more baits were still soaking in the surf. The "What if" then happened.

The fish I had was headed off-shore and down the slough, and the second rod went off. Then, the third went off. My situation was (1) I had three rods; (2) I had two hands one of which was slightly scalded from the coffee spilled on it during the excitement when the first fish hit; (3) I was alone; (4) I had three large red drum on; and the 20 pound test line was quickly disappearing from the reels.

I cradled the first rod in one arm and grabbed the second. Fortunately, it went slack as that fish got off. The fish on the third reel was hung solidly and I didn't have much line on the spools of either reel. When I tightened the drag on the third reel, it went slack.

I then refocused my attention to the first rod. The fish had left me about 75 yards out of the 300 on the spool. Slowly I walked down the beach in the direction of the fish, lifting and dropping my rod tip and cranking the reel as I went. Some line was retrieved, but it was touch and go. The fish was tiring because its runs were slower and shorter now.

After some time (I have noticed that anytime you catch a large fish, the first thing people ask you is how long it took to land the beast. I don't know about you, but when the drag on my reel screams, the last thing I look at is my watch. In addition, watches should be banned on barrier island beaches.) I had worked the fish to the breakers near the beach. I waded out into the water and waited until the fish could be surfed onto the beach by a wave.

As the foamy sea receded, the red drum was stranded on the sand. After removing the hook and setting the rod down on the beach, I walked the 40 to 50 pound red drum back into the surf. There, after being pushed and pulled to get seawater flowing across the gills, the fish splashed, and with a thrash of the tail, swam off into the dark water.

I retrieved my rod and started down the beach towards the faint outline of the truck which was about half a mile up the beach. The lawnchair was over turned and the coffee cup was half buried in the sand. The other lines were reeled in and one lacked bait and the other terminal tackle.

For a brief instant I thought about baiting up again and giving it another shot. Instead, sand was rinsed from the coffee cup, and it was filled with a generous portion of brown fluid that served as emergency medication. Sitting in the chair, I toasted the powerful red drum who had provided such a wonderful night. Salutes were also made to the two fish that got away. Still dressed in waders, alone on a barrier island beach with good thoughts in tow, sleep overcame me.

The next day, a fisherman that I knew fairly well asked how I had done. "Not much. One wimp I threw back. So slow I fell asleep in my lawn chair. Don't waste your time. You do anything last night?" I said as plans for the next night were being made in my mind. Secrecy is a must for folks like me who are allergic to people when drum fishing at night. That story is gospel as I remember it, and now let's get back to the task at hand.

Surf fishing for red drum requires the use of fairly heavy tackle since the angler will be casting a 3 to 8 ounce sinker plus a relatively large piece of bait. Also, there is the possibility of hooking a trophy-sized fish in the 40 pound class. The surf is not the place to challenge red drum with light or ultra light tackle. This point was well illustrated to me one day while fishing for red drum with a friend. We caught a few fish in the 5 to 15 pound range, and he was using light tackle (medium-light action rod, 12 pound test line). This gear was adequate to handle the fish thus far encountered. I issued warnings to switch to a heavier rod, however, as a "sportsman" he continued to use the light weight gear. Shortly thereafter, his rod bowed, the drag screamed, and the fish took off for parts unknown. After a good, quick run which took almost all the line on the lightweight reel, panic set in. Additional pressure was applied to the drag in an attempt to turn the fish, and the line parted. He looked at me with as sad a look as I have ever seen and said "You shouldn't go bear huntin' with a 22." Enough said about light tackle in the surf.

Although there are probably as many different variations in the tackle used in surf fishing as there are anglers, I will try to describe the types of equipment that have worked well for me. I prefer a spinning rod, 9 to 13 feet in length, strong enough to handle heavy terminal rigs and large fish. Surf rods are manufactured out of two general types of materials, fiberglass or graphite. Those made of graphite are light and strong but are more expensive than fiberglass.

My six surf rods are all one piece, fiberglass. I avoid those made in two sections that are joined with a ferrule. My distaste for them stems from the weakness of the two piece rod in comparison to the one piece. Several times, I have seen these break at the connecting point when fighting large fish. It may be difficult to find a one piece surf rod of

the appropriate length, but once found, you have a piece of equipment well worth the trouble. Catalogues from outdoor sporting equipment suppliers generally do not offer one piece fishing rods over 7 feet in length because of shipping problems. To get a good, one-piece outfit, you will either have to order a custom built one from a full service tackle shop or purchase a blank and the associated hardware (reel seat, guides, grips) and build your own. There are several "How To" books available that can be ordered from **Saltwater Sportsman**, that provide step by step instructions on rod building and repair. If you have the time and patience to undertake such a task, the monetary savings can be considerable. If you can't procure a good one piece rod, most coastal tackle stores carry a reasonably good line of two piece surf rods.

An important consideration is the type of guides on the rod. Over time, the passage of monofilament through chromed stainless steel guides causes them to groove. This in turn, frays the line making it weak and likely to break. Newer composite metals and ceramic guides have alleviated this problem, however, when purchasing a rod, look closely at the guides. If metal, ask the dealer about their resistance to grooving by monofilament fishing line.

The spinning reel should be balanced with the surf rod and have a large line capacity. As a minimum, I would recommend that the reel hold at least 250 yards of 20 pound test monofilament. Trying to save money by purchasing an economical surf reel is an unwise decision. Buying a reel is like buying a tool. A quality tool will cost more, but will last longer and perform better. Get a good, dependable reel; remember you go fishing for pleasure, and cheaply made, malfunctioning equipment can ruin an outing. Be sure to purchase a spare spool for your reel and fill it with the appropriate line. If you have a problem with the line, you then have the option of changing to a new spool.

When you go into a quality tackle store

or browse through a catalogue of a large mail order house that specializes in fishing tackle, the diversity of fishing lines is usually amazing. Prices range from low to extremely high. For example, in a recent catalogue, prices for a 650 yard spool of monofilament ranged from \$6.50 to over \$20.00. For surf fishing, I prefer clear Ande 20 pound test monofilament line. I have found it to be strong, resistant to abrasion, and available in 1/4, 1/2, and 1 pound spools at moderate prices. Other manufacturers such as DuPont, Berkeley, and Shakespeare produce quality lines that are satisfactory. It is largely a matter of personal choice, however, very cheap line is generally stiff and has a tendency to tangle easily. Do not be shy about changing line if the spool becomes low or the line is badly twisted or abraded.

Terminal tackle consists of hooks, leaders, swivels, and sinkers. The size of the sinker needed to tend bottom without drifting depends on surf conditions. If the surf is small or moderate, a two or three ounce pyramid sinker should be sufficient to hold bottom. However, rough surf and strong longshore currents require heavier sinkers. At times a six to eight ounce pyramid sinker is needed to keep the bait stationary. Successful surf fishermen usually carry several sinkers of different weights and select the proper size for the conditions. Do not use more than the minimum weight necessary.

A very popular arrangement of the terminal tackle is called a "fish finder" rig. Basically the line above the swivel, leader, and hook is threaded through a nylon "slider" to which the pyramid sinker of appropriate weight is attached by means of a connector. The theory behind this rig is that when a fish picks up the bait, it will not feel the weight of the sinker. Current thought is that if a fish feels the weight of the sinker, it will not take the baited hook. The remainder of the rig includes a #3 (65 pound test) or a #5 (100 pound test) black finish, brass barrel swivel secured to an 18 to 24 inch

monofilament leader (50 to 80 pound test) with a 5/0 to 9/0 O'Shaughnessy hook. I use clinch knots to put the tackle together (Figure 20 & 21).

Some anglers who fish with cut bait in the surf use Tuna Circle Hooks, a hook style that has been part of the tackle of commercial fisherman for many years. Size 6,7, or 8 (Figure 22) can replace the O'Shaughnessy hook on the fishfinder rig. I make one minor modification to this style of hook. They are manufactured without an off-set, that is, the part of the hook that curves up to the point is in the same plane as the shank. To modify it, I place the shank in a vice and bend the terminal end of the hook to one side with pliers to off-set it slightly. In the second general type of surf rig, the sliding nylon sleeve is removed and a 3 way swivel is substituted for the barrel swivel. The line from the reel, leader, and pyramid sinker are all connected together at the swivel (Figure 23). As in the fish finder rig, a tuna circle hook can be substituted for the O'Shaughnessy hook.

During the best times of the year for catching trophy red drum in the surf, fairly large sharks are present along our barrier island beaches. Since a shark can and frequently does bite through even heavy monofilament, a different type of leader

material will increase the probability of successfully hooking and holding one of these "toothy critters" in the surf. Therefore, some fishermen substitute 40 or 60 pound test nylon coated stainless steel cable for the monofilament leader. Instead of knots, the leader material is joined to the hook and swivel by means of crimped sleeves. The cable is available both coated with nylon and uncoated. Sleeves are specifically manufactured for a given size of cable, and the angler needs to be sure that when purchasing them, the sizes match. Many red drum fishermen use cable leaders for the added margin of protection it provides.

I have always used the stationary sinker rig for two reasons: (1) when casting the fishfinder, the sinker has a tendency to slide up the line and reduce the distance of the cast; (2) it has been my experience that the fishfinder rig fouls frequently and you end up with a mess at the end of your line. However, some of the best surf fisherman I have known, use a fishfinder exclusively, and you can't argue with success. Both work, so use the one that is most comfortable for you.

The last type of surf rig has two hooks and is generally used when the smaller, subadult red drum are available in an area. The sizes of the components are smaller than

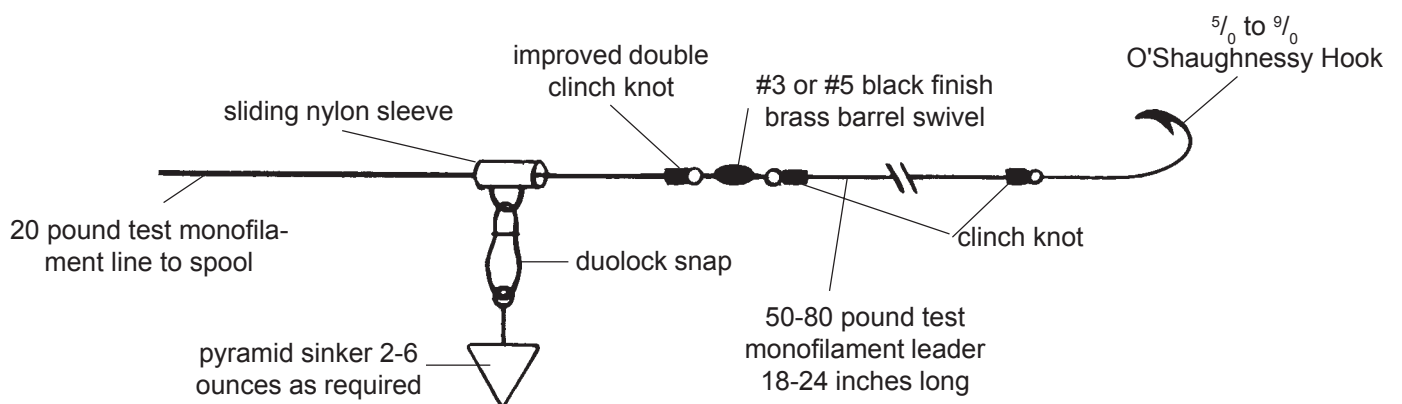

Figure 20. Diagram of a fish finder rig.

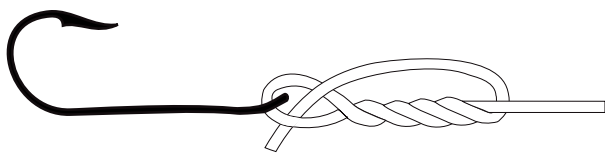

Fig. 1 Pass the end of the leader or line through the hook eye, and pull about six inches of line through to tie the knot. Bring the end of the line back toward the stand-

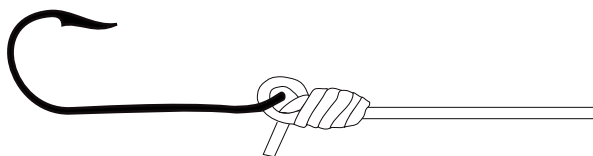

Fig 2. Slowly pull on the standing part of the line, and the line's end, until the turns in the knot draw tightly against the hook eye.

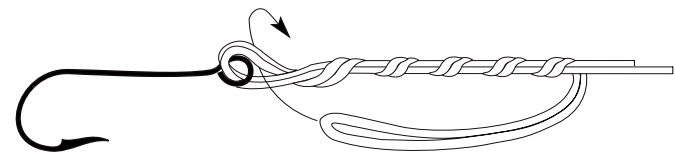
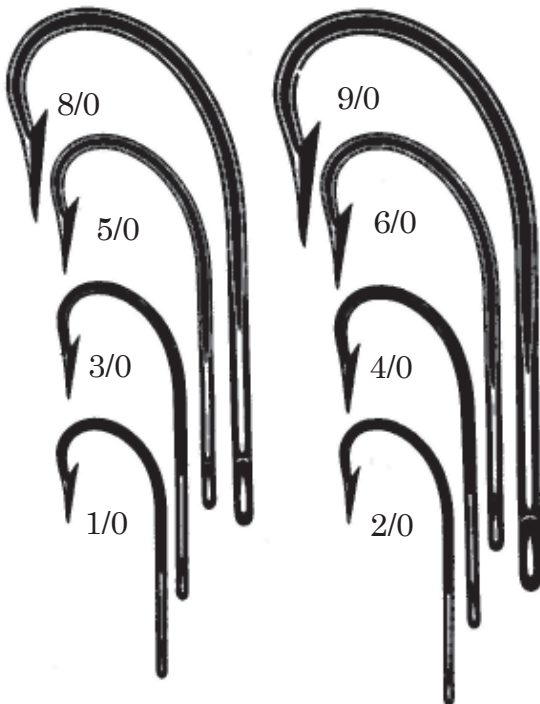

Fig. 1 Double the line, bringing the line end back parallel to the standing line so there is about eight inches of double line. Take the end of the double line and push it through the hook eye. Wrap the doubled line end five times around the doubled standing part of the line, and push the line end back through the loop formed near the hook eye.

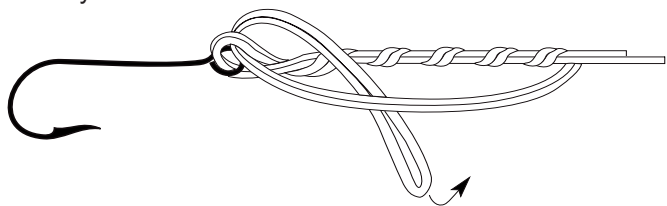

Fig. 2 Pull the doubled line end through the loop in front of the hook eye, then push the end through the large loop as shown.

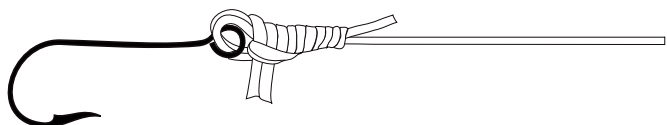

Fig. 3 Moisten the knot with saliva, then pull tight.

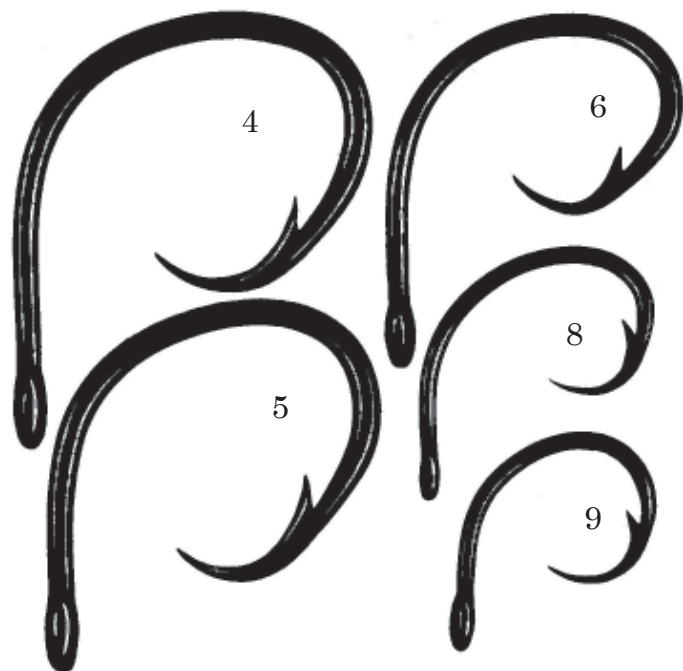

Figure 21. Clinch knot (upper) and improved double clinch knot lower for connecting terminal tackle together.

Figure 22. Some sizes of O'Shaughnessy hooks upper and tuna circle hooks lower. Actual sizes.

the other types since smaller fish are generally targeted (Figure 24). The two hook style bottom rig can be used to catch whiting, Atlantic croakers, or spot in the surf after smaller hooks (#1, 1/0) are substituted for the 3/0 or 4/0 hooks.

In coastal South Carolina, most of the good surf fishing spots are accessible only by boat. Usually, the boat is anchored behind a barrier island or an off-shore bar in protected water. Gear must then be carried to the fishing area, a distance that varies from several hundred yards to several miles. If you're like me, you neither want to transport any more stuff than necessary nor forget something in the boat and have to walk back to get it. To help those who have never tried the sport to get started, I have listed below some of the essential equipment.

Since surf fishing for red drum peaks in spring (April - May) and fall (October - November), water temperatures will be below 70°F. Therefore, a pair of chest waders is a must. They are produced by several manufacturers at a variety of prices. One note of caution. Do not ride in your boat to and from the fishing site with your waders on. If you should happen to fall overboard and the waders fill with water, you could drown.

When surf fishing from the beach or on an off-shore bar, you have two choices. Ei-

ther you can stand for 2 or 3 hours holding the fishing rod or you can use a sand spike and set the rod in it. To me, a sand spike is a must and is frequently the most overlooked piece of surf fishing equipment. A well designed spike can make a surf fishing trip much more pleasurable. However, beware of cheaply constructed sand spikes made of lightweight materials; they lack durability and provide little service.

The sand spike can be used to not only hold the fishing rod but also the bait and a stringer for your catch. Figure 25 provides a general plan for one that is easy to construct. On the top eye you can attach a small bait bucket with a brass or stainless steel snap eye which can be purchased at a hardware or marine supply store. Any small pail with a handle and a lid can be used for bait. I would suggest adding some salt to the bait to toughen it and prevent spoilage. Frozen cut bait, even when salted after thawing and cleaning, is not very good because it does not stay on the hook as well as fresh bait. Live bait works best, but it is very hard to keep alive when surf fishing.

Since it is no fun carrying a heavy tackle box long distances down the beach to the fishing location, a minimum amount of extra tackle that might be needed should be taken. The spare tackle includes several

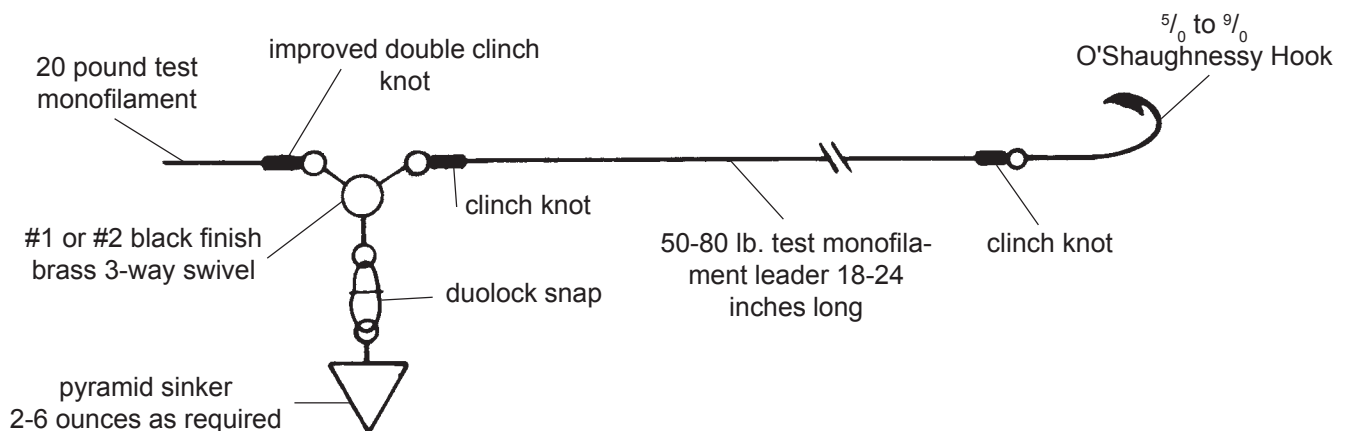

Figure 23. Diagram of a surf fishing rig for red drum.

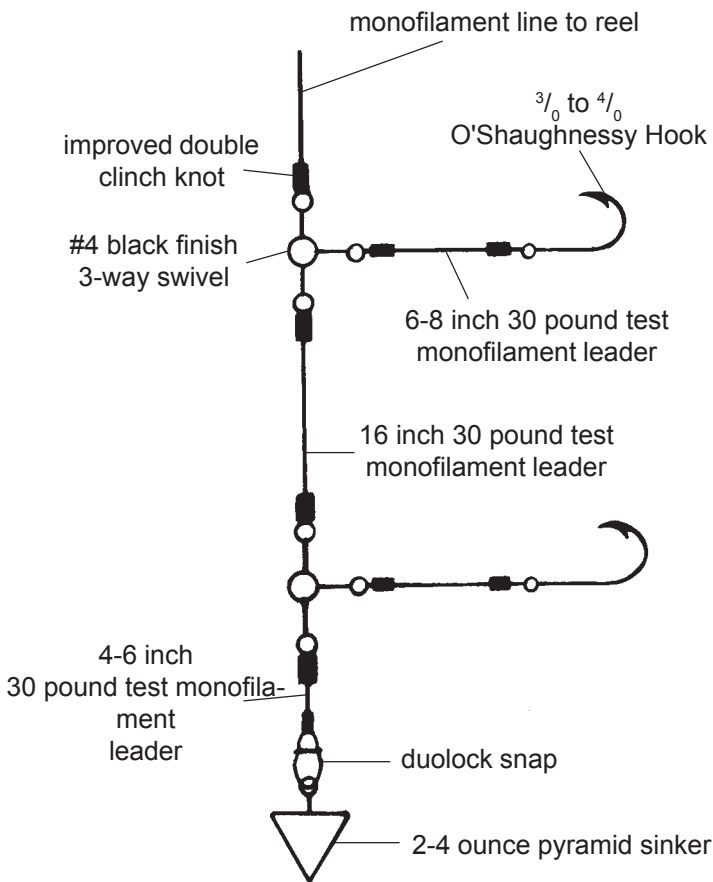

Figure 24. Two hook surf rig.

terminal rigs, an extra spool of the appropriate pound test fishing line for the reel, additional pyramid sinkers of different weights, and either a pair of needle-nose pliers or one of those gadgets to remove hooks from the catch. Also, when fishing at night, I use a small disposable pocket flashlight secured to a string with plastic electrical tape and hung around my neck. Prior to the fishing season, I put together about 50 terminal rigs for surf fishing. Each one is individually placed in a small zip-lock bag to prevent tangling, and stored for later use. Packaged in this manner, they are convenient to carry.

Best fishing is on the rising tide. Experienced anglers arrive at the beach at low tide to identify the deeper holes. To locate these, carefully observe the profile of the beach. If the beach slopes gently, the water

offshore is shallow (Figure 26). If the profile is steep, waves break close to shore carrying away sand and leaving deeper water. By observing the breakers, you can locate deeper holes and cuts. Since red drum move into these deeper areas on the incoming tide to feed, fishing the cuts increases your chances of catching a red drum.

It has been my experience that more trophy-size red drum are caught at night than during the day. The old timers and those anglers who catch many large red

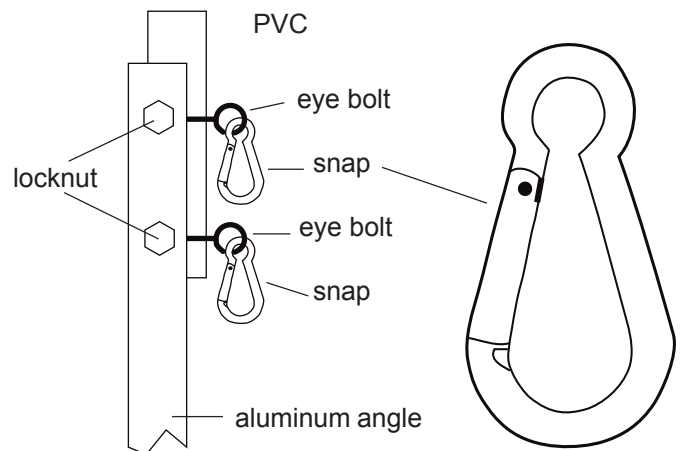
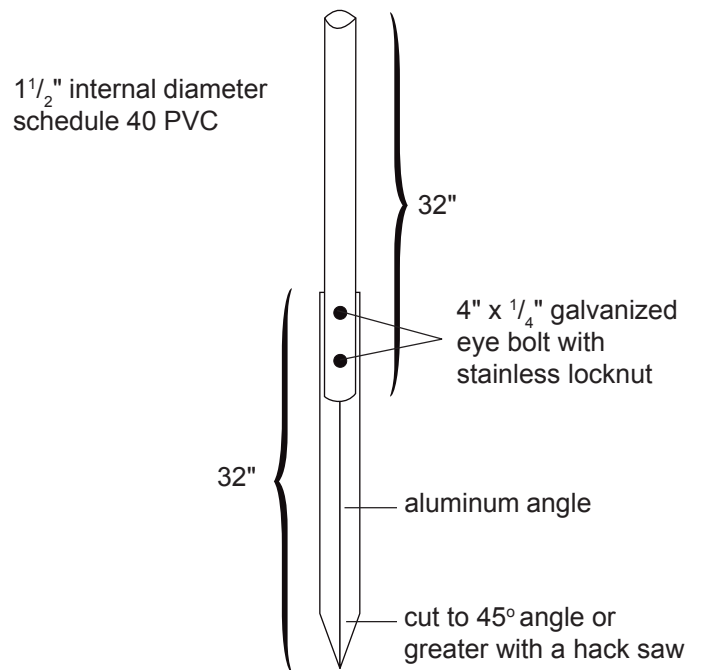
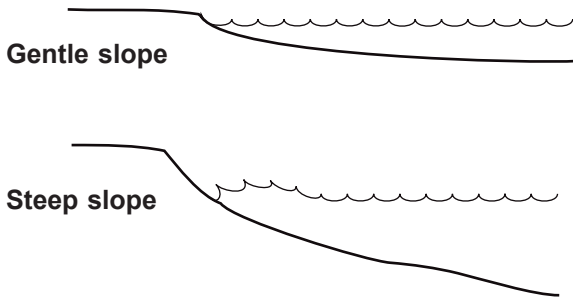

Figure 25. Sandspike for surf fishing.

Gently sloped beaches have the waves breaking off-shore with most energy being dispatched before the wave reaches the beach.



Steep sloped beaches have the main force of the wave breaking very close to shore which scours out a deeper area.

The off-shore bar will have a cut through it where the beach has a steep slope; fish move through this cut to feed along the beach.

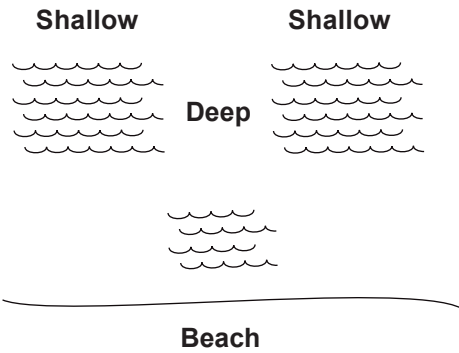

Figure 26. Read a beach to locate cuts and fioles.

drum, fish mainly at night. Very few people know where they go, when they go, or even if they are successful. Surf fishing for red drum makes people kind of “close to the vest” with their knowledge.

There are many beaches along South Carolina’s coast where a surf fisherman can do battle with a red drum. Remember that the topography of the beach changes seasonally and annually, and you can not simply go to a site, cast in a bait, and expect to catch a red drum. Study the lay of the beach and consider it from a fish’s perspective. Ask yourself the question “If I was a red drum

where would I go to obtain the maximum amount of food for the least effort?” Although in the surf they feed on other fishes like spot, they primarily eat crabs (which are also a good bait). The surf breaking on the bars frequently uncovers crabs that are partially buried in the sand. These make the red drum’s supper. Cuts in the bars provide the “highways” for the large fish to move and feed. Good luck and good surf fishing.

Boat Fishing

By far most red drum are caught in coastal South Carolina by anglers who fish from boats. These individuals stalk the creeks, bays, sounds, inlets and waters in front of the barrier islands. In the protected waters of the creeks and the smaller bays, red drum range in size from less than the minimum legal size of 14 inches in total length to a few fish in the 15 pound range. In the lower parts of the estuary, around inlets and on the oceanic side of barrier islands, small, medium and trophy size red drum can be caught.

To better understand how, when, and where to catch red drum inside the estuaries, the previous information about their movements and diet is helpful. The subadult red drum inside the estuaries move with the tide. Previously, I explained that one of its favorite foods is fiddler crabs. These crustaceans live in burrows that are underwater only during those periods when the tide floods mudflats and the marsh surface. In places where large areas of marsh that have dense populations of fiddler crabs are flooded at high tide, red drum move up on the marsh surface to feed. If you drift along the shallows adjacent to such an area at night around low tide when the water is clear with a spot light, frequently either red drum or their “vapor trails” (a line of sediment that is suspended in the water by the rapid escape of the startled fish) can be seen. Most often, red drum can be observed around the sub-

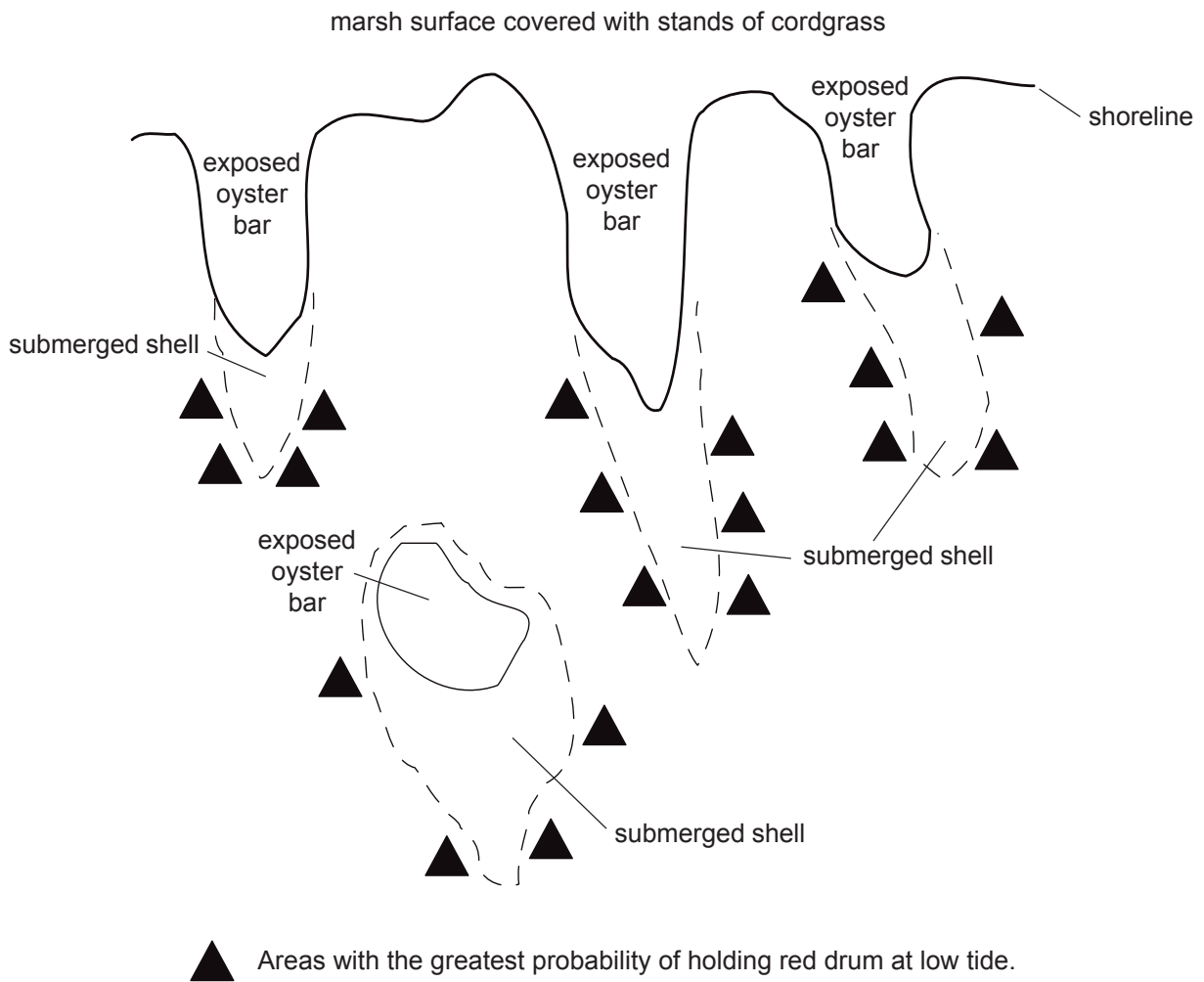

Figure 27. Diagram of a shoreline with exposed and submerged oyster reefs at low tide demonstrating where red drum might be located around low tide.

merged edges of oyster bars in water that may be only 6 to 8 inches deep (Figure 27). On occasion, you might find them with their backs sticking out of the water.

When gigging (graining) was permitted year round, those individuals that participated in this sport, would wait until an “Alberta Clipper” would come through the area in January or February. As this fast moving cold front passed, cold northwesterly winds would drop the air temperature to freezing or below. Strong winds would stir and cool the estuarine water quickly. After a hard blow of a day or two, the winds diminish, and the waters inside the estuary clear.

It is then that red drum would be easy targets for the barbs of a gig because of their inability to regulate their body temperature which results in the fish becoming sluggish and slow moving in these cold waters. Gig fisherman would venture out on the early incoming tide on these clear, cold nights in boats equipped with lights to illuminate the shallows, these “cold stunned” red drum were easy targets. I have seen old photographs of giggered red drum from four to ten pounds covering the bottom of a pickup truck’s bed. Most gig fishermen would stop patrolling the shallows when the water reached the marsh surface because as the

flats of *Spartina* (marsh grass) became flooded, red drum moved into the grass. Although present law does not permit gigging during the colder months (December through February), it is still permitted during the warmer months. As with harvest by rod and reel, the minimum legal size is 14 inches total length and the bag limit is five red drum per person per day.

How does all this pertain to catching red drum with a rod and reel? If red drum inside the estuary move on to the surface of the marsh to feed at high tide, the best time to go for them is the period around low tide when they are concentrated in the shallows and therefore available to boat fishermen. It's tough to fish in the dense strands of marsh grass. However, some people fish in the high marsh areas. These anglers sight cast to "tailing" red drum.

One point to keep in mind is that not all red drum move onto the flooded surface of the marsh at high tide. However, enough of them do in many areas that the chance of catching a fish inside the estuary are greater from mid-ebb tide to mid-flood tide which is when they are restricted by water depth from going into the grass.

Subadult red drum can be taken with either natural or artificial baits inside the estuary. Most anglers use either live or dead natural baits as opposed to artificial lures. The preferred natural baits are shrimp (alive or dead), mud minnows, mullet (alive or dead) and crabs (alive or dead). When subadult red drum are not on the marsh surface, they are generally found around structure which includes things in the water like old pilings and dock rubble, rocks, or oyster bars. If you refer back to the section that details the food of subadult red drum, small crabs other than fiddlers are frequently eaten. These are most abundant around structures and red drum move along these, feeding on the crabs.

For a rod and reel combination, I use either a seven foot long light action, one

piece fiberglass rod with ceramic guides and a spinning reel filled with eight pound test monofilament line or a six foot long medium action, one piece fiberglass rod with ceramic guides and a spinning reel with six pound test monofilament line. The seven foot combination is light enough so that 14 to 16 inch long red drum give a reasonable fight when hooked, yet strong enough to handle a fish in the eight to ten pound range. The lighter outfit is used when the fish are mostly small. On both rigs, a 15 foot shock leader of 12 (seven foot rod) or 10 (six foot rod) pound test monofilament is secured to the main line with a blood knot (Figure 28). This is a strong knot when properly tied and is small enough to pass through the rod guides easily.

Natural baits can be either fished off the bottom by using a float or on the bottom with a weight. Both are effective, however, I prefer to fish baits on the bottom because red drum are primarily bottom feeders. By using bottom rigs around structure, you will lose more terminal tackle than by float fishing, but the reward is more strikes. The two most widely used floats are the balsa wood casting float (the favorite of most anglers) and the popping cork. The latter gets its name from the concave depression on the top of the float that will cause a surface disturbance and a popping sound when the rod tip is raised smartly. Here it acts like a surface plug calling the fish's attention to the fact that there is a bait drifting by directly below the float. They come in weighted or unweighted models with the weighted type preferred because of the small amount of lead in the bottom will make it easier to cast and will also make the float ride better in the water. The basic plan for this terminal rig is shown in Figure 29. The depth that the bait is fished can be changed by removing the plastic rod, sliding the float up or down the line as desired, and resealing the float on the line by wedging the line against the float with the plastic rod. A small piece

of split shot above the hook will tend to keep the bait at the desired depth, and the hook can be secured to the leader with a clinch knot or a Palomar knot which is easy to tie and strong (Figure 30). At the business end of the rig, I prefer to use either a 1/0, 2/0 or 3/0 bronze, short shank O'Shaughnessy hook. Several things need to be considered when selecting a size and style of hook. First, a bronze hook will rust quickly, so if the fish is released with this type of hook still in it,

the chances are much better that the hook will decompose. This hook is less expensive than those that are either cadmium or nickel plated or stainless steel, all of which are rust resistant to a greater or lesser extent. Second, when choosing a hook for live bait, I prefer to use the largest one that will allow the bait to act as naturally as possible considering the circumstances. Third, the larger the hook used, the fewer fish that will be gut hooked. This is important because

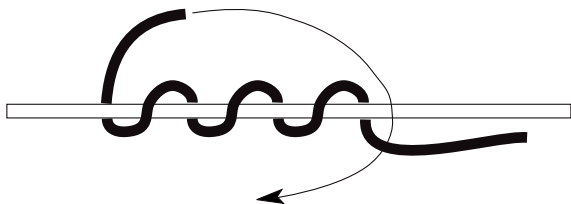

Fig. 1 Cross two sections of monofilament and wrap one section three or four times around the other. Now place the wrapped end through the loop formed by the two mono sections.

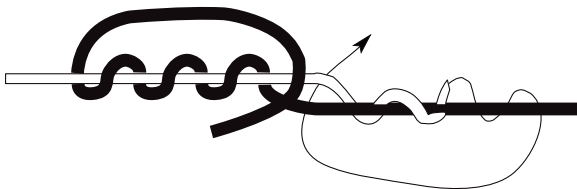

Fig. 2 Turn the other line around the standing part of the first line three or four times, and put its free end through the loop from the opposite side.

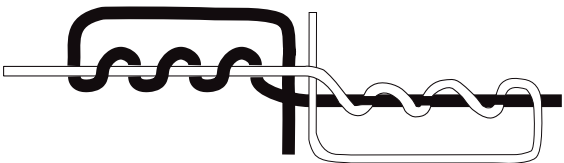

Fig. 3 At this stage the turns should look the way. Now slowly pull on both ends of the line.

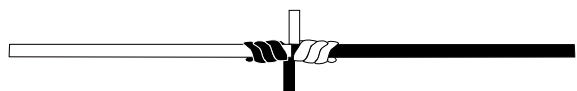

Fig. 4 With its ends trimmed closely, the finished knot looks like this.

Figure 28. Blood knot to join 8 pound test monofilament main line with 12 pound test shock line.

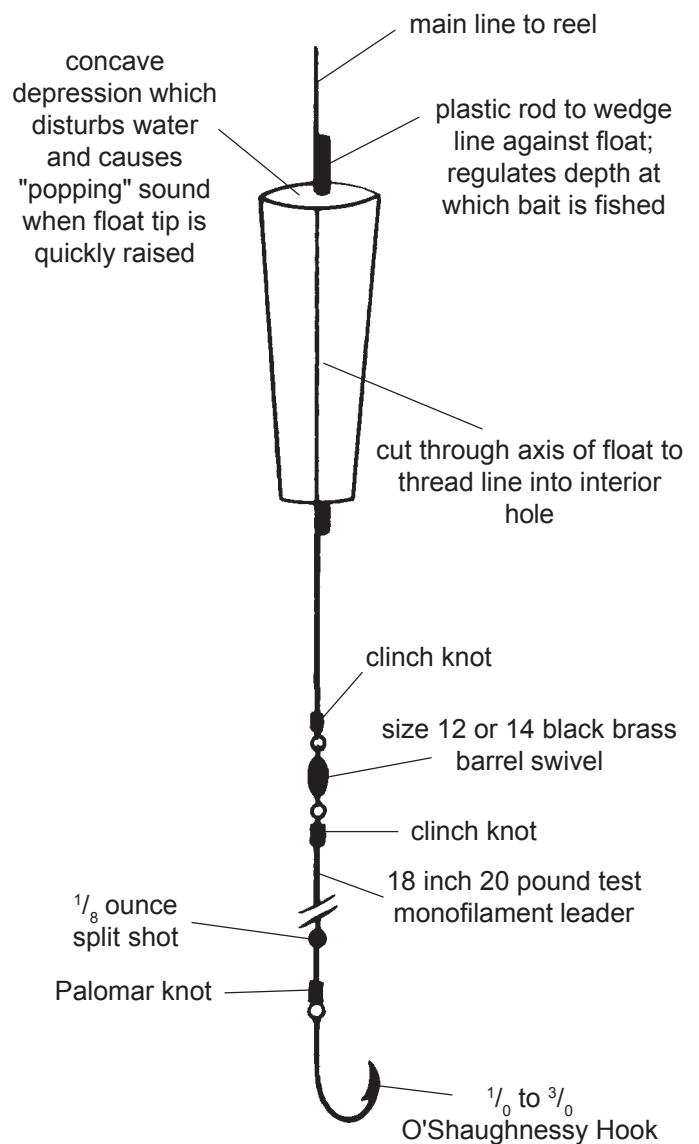

Figure 29. Popping cork for float fishing with live bait for red drum around structure.

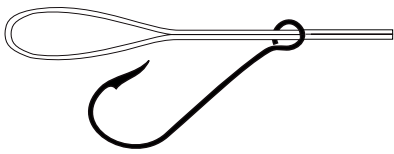

Fig. 1 Double the end of the line and pass the loop through the hook eye.

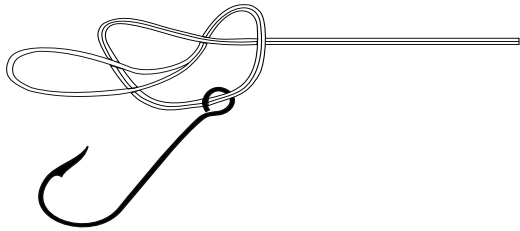

Fig. 2 Double the loop back, then make an Overhand Knot around the standing line, leaving a loop large enough for the hook (or lure) to pass back through.

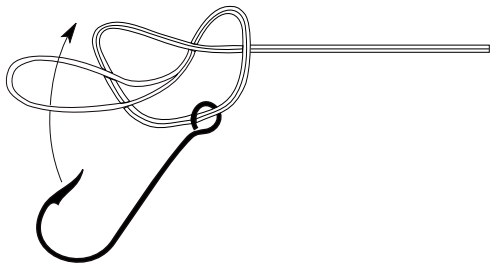

Fig. 3 Put the entire hook (lure) through the loop, as illustrated.

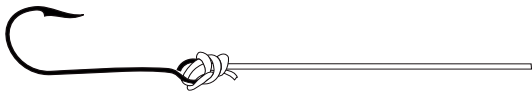

Fig. 4 Pulling on the standing line will draw the knot tight. Trim it, and the knot will be compact and effective.

Figure 30. Palomar knot for securing hook, swivel or lure to the line.

when fishing the shallows in the early fall, the angler will catch some sub-legal red drum less than 14 inches total length. If you use a very small hook (#2 or #1), there is a greater probability of gut hooking and causing a severe injury to the fish. Fishes that are gut hooked have a lower probability of surviving. When the available baits are small, I switch to a lighter style hook such as a 1/0, 2/0, or 3/0 Aberdeen hook which will allow the bait to swim naturally rather than going to a

smaller size hook.

When fishing for red drum with live bait on a popping cork, first find a location with structure at mid-ebb tide to early flood tide. Adjust the depth of your bait so that it is off yet reasonably close to the bottom. Cast the rig into the desired location and let the bait drift. Every so often with the line tight between the rod and the float, lift the rod tip smartly. This will result in a surface disturbance with a popping sound.

The other popular type of float used in live bait fishing is the balsa wood casting float. The configuration differs from the popping cork (Figure 31). To regulate the depth that the bait is fished, a knot of cotton twine is slid up or down the main line. The egg sinker brings the bait down to the desired depth and the small plastic bead jams against the cotton knot. If when fishing this, the float lays on its side, either the bait is set too deep and the weight is on the bottom, or the egg sinker is not heavy enough to make the float ride correctly in the water. To correct this problem, first shorten the depth by sliding the knot towards the terminal end. If this does work the float still rides improperly, remove the egg sinker and substitute a heavier one.

Cotton stoppers for balsa wood casting floats only last one trip, and sometimes do not make it through an entire outing. Unfortunately balsa wood casting floats are not sold with an extra stopper, so in an emergency, I attach a rubber band to the line with a couple of overhand knots. This has its shortcomings because the rubber band does not pass through the guides of the rod cleanly and has a tendency to slide, so you end up constantly adjusting it. Replacement cotton stoppers can be purchased in tackle stores for about \$1.50 for a package of three. A procedure for making replacement cotton stoppers using a hollow plastic coffee stirrer, a spool of heavy cotton thread, and a pair of scissors (I also need my bifocals) is provided in Figure 32.

To fish the balsa wood casting float rig, simply cast the bait out to the desired location, let it drift around the structure and wait for it to be pulled under. Wenner's law of float fishing states that "a fish will not strike a live bait and pull the float under unless the angler is opening a beer or soda, eating a sandwich, or lighting a cigar, pipe, or cigarette." Next time you're float fishing with live bait, keep a mental record of when you get strikes. I guarantee most of them occur when both hands are occupied with food, drink, or smoking materials.

The basic rig for bottom fishing with

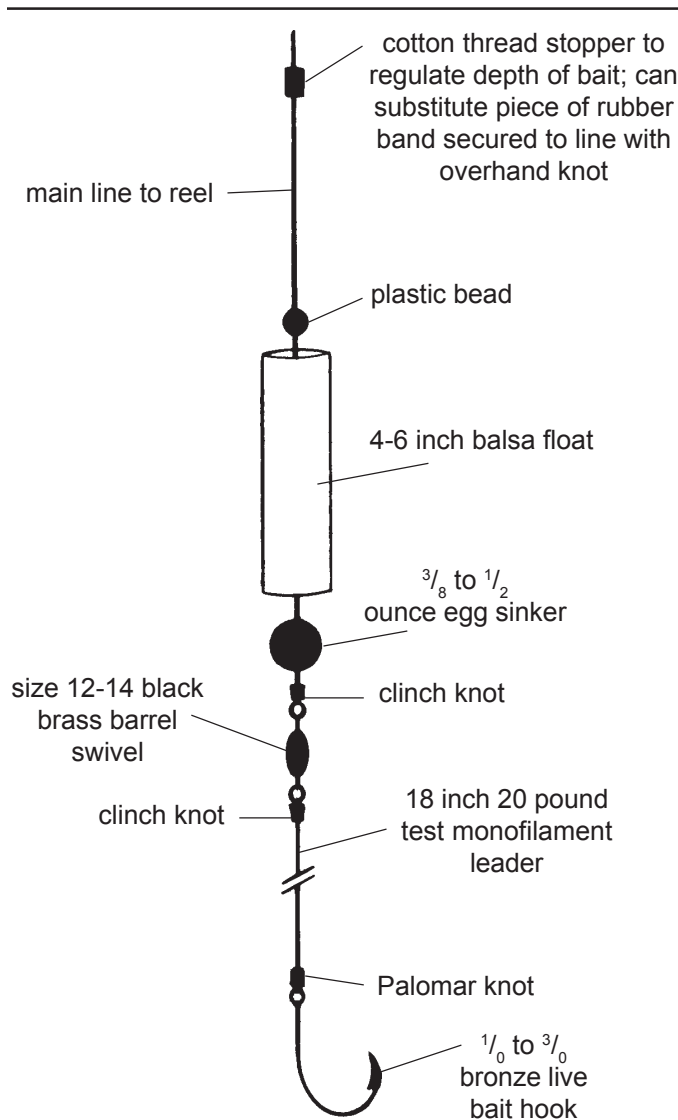

Figure 31. Casting float for live bait fishing for red drum.

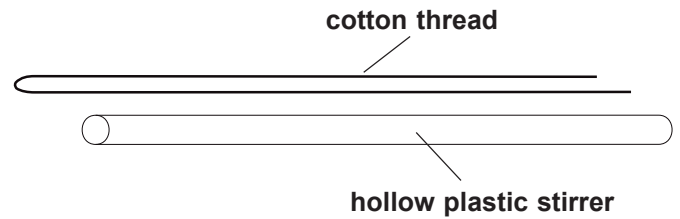

Fig. 1 Cut about an 8 inch long piece of cotton thread; double it to form a loop about 4 inches long; lay the loop parallel to the stirrer.

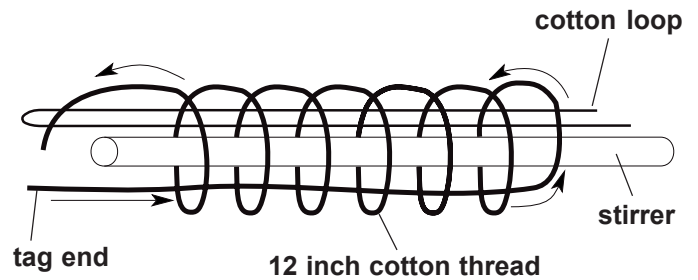

Fig. 2 Place the tag end of a 12 inch piece of cotton thread at the same end as the loop; make 7 turns or whips around the stirrer, the loop and the portion of the line going to the tag end; make the whips beginning away from the loop and working towards the loop.

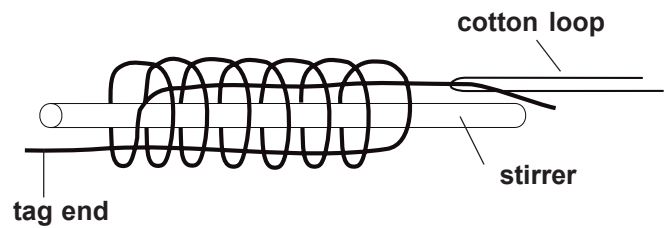

Fig. 3 Place the end of the thread through the loop and pull the loop carefully from under the whips; after thread is pulled through, pull gently on each end of the thread to snug it down on the stirrer.

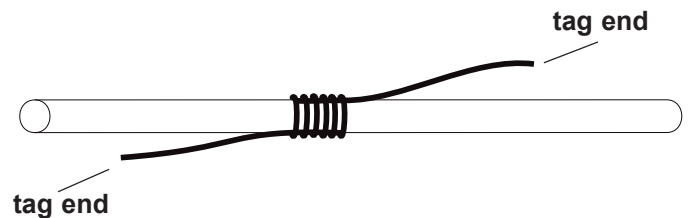

Fig. 4 Slide the knot down the stirrer; trim long ends to appropriate length and cut the stirrer to desired length (an inch or two). Store in small compartment of tackle box.

Figure 32. Construction details for stopper knot used in float fishing with live bait with balsa casting floats.

either live or cut bait is quite simple (Figure 33). I use the lightest sinker that will keep the bait in place, and frequently in quiet areas with no current, the egg sinker is removed and a small split shot is fastened to the leader directly below the swivel. When fishing with either cut or live bait with this type of tackle around structure, fish the bait at the edge of the obstruction. Do not cast the bait directly into a clump of oysters, because you'll never get it back. Even when you just fish the edges you will lose a lot of tackle. I usually keep about a dozen rigs ready to fish, each individually packaged in small zip lock bags, in my tackle box.

In the coastal areas of our state, most fisherman use a cast net to catch shrimp, finger mullet, and small menhaden for bait. Mud minnows are most easily caught with a minnow trap. The best time to get finger mullet and shrimp is the period around low tide when they are concentrated in the shallow creeks. It's almost impossible to catch bait around high tide because bait animals are dispersed, usually on the marsh surface. A good general size for a cast net is one that has a radius of five feet. When thrown properly, the net will cover about 70 square feet of bottom. I prefer a monofilament, fast sinking net such as the Betts DeLux Model which is available in most full service tackle stores. Minnow traps are constructed out of 1/4 inch mesh, galvanized hardware cloth, and are available in most tackle stores for

less than \$10.00. Mud minnows inhabit the small, shallow creeks that cut through the marsh, and traps baited with a piece of crushed blue crab or some fresh fish will catch them.

Once you have the bait, the next question is how do you keep it alive? There are several options which vary in cost from almost nothing to about \$100.00. Mud minnows are very hardy and can be kept in a bucket partially filled with water as long as the water does not get too hot, the minnows are not overcrowded, and the water is changed often. Shrimp, finger mullet and menhaden could not make it for long under such conditions. Another alternative is a minnow bucket that has many small holes in it that permit water flow through the pail when it is placed over the side. It is shaped so that if you are trolling, the bucket pulls through the water nicely. Mud minnows, shrimp and finger mullet do reasonably well in it, however, the capacity of this style of bucket is small. The cost is less than \$15.00 and it is readily available in most stores that carry fishing tackle. Other alternatives are "bait savers" which come in 5 or 10 gallon models. These are plastic buckets with hinged lids and aerators that oxygenate the water. The aerator runs off a 12 volt battery and comes with battery clips. These sell for \$40 to \$60 and are quite good for mud minnows, shrimp and finger mullet. An advantage of these is that they come ready to use,

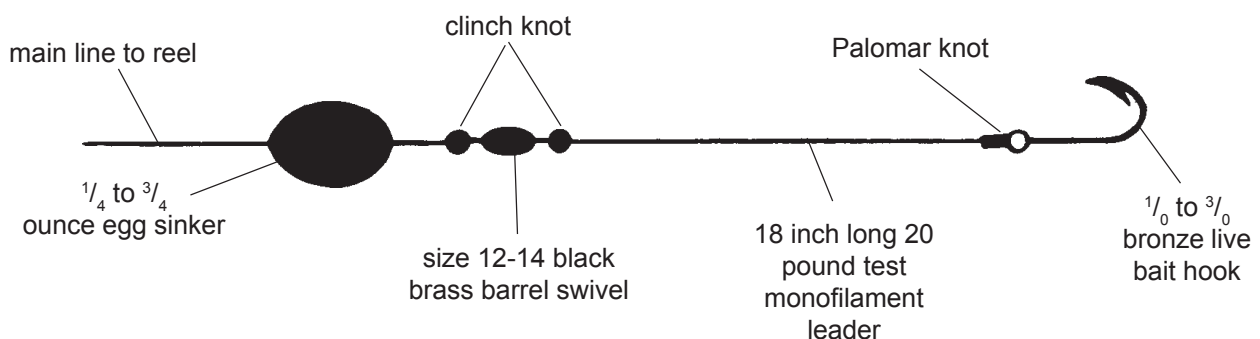

Figure 33. Bottom rig for live bait fishing for red drum.

however, during hot weather the water needs to be changed occasionally. For \$30 to \$40, kits with bilge pumps, wiring and aerator hoses can be obtained; these convert standard ice chests into bait wells.

The system in my boat is probably the most satisfactory for keeping large quantities of all types of bait alive for long periods (Figure 34). This system consists of a water pump mounted on a stainless steel bracket which is fixed to the outside of the boat on the transom, hose from the pump to a plastic barrel, an overflow from the barrel that goes outboard, wiring to a switch, and the battery. The beauty of the system is that it is continuous flow and new water is constantly added and in hot weather, temperature does not cause a problem. When the inflow pipe

has a 45 degree elbow fitting place on the inside, a current can be set up with the incoming water. Many baits prefer to be in a slight current. All bait fishes and shrimps that I have kept in this system which costs about \$40 (plus the plastic barrel) have done very well. I have held more than 100 menhaden in the tank all day and this species is notorious for being difficult to keep alive in bait systems.

There are opportunities for catching trophy bass from boats. The places are mainly around the mouths of inlets and on the ocean side of barrier islands either near offshore bars or the front beach. If you are seeking large fish in these areas, the old axiom that "large baits catch big fish" applies. I prefer to use larger (6 to 8 inch long)

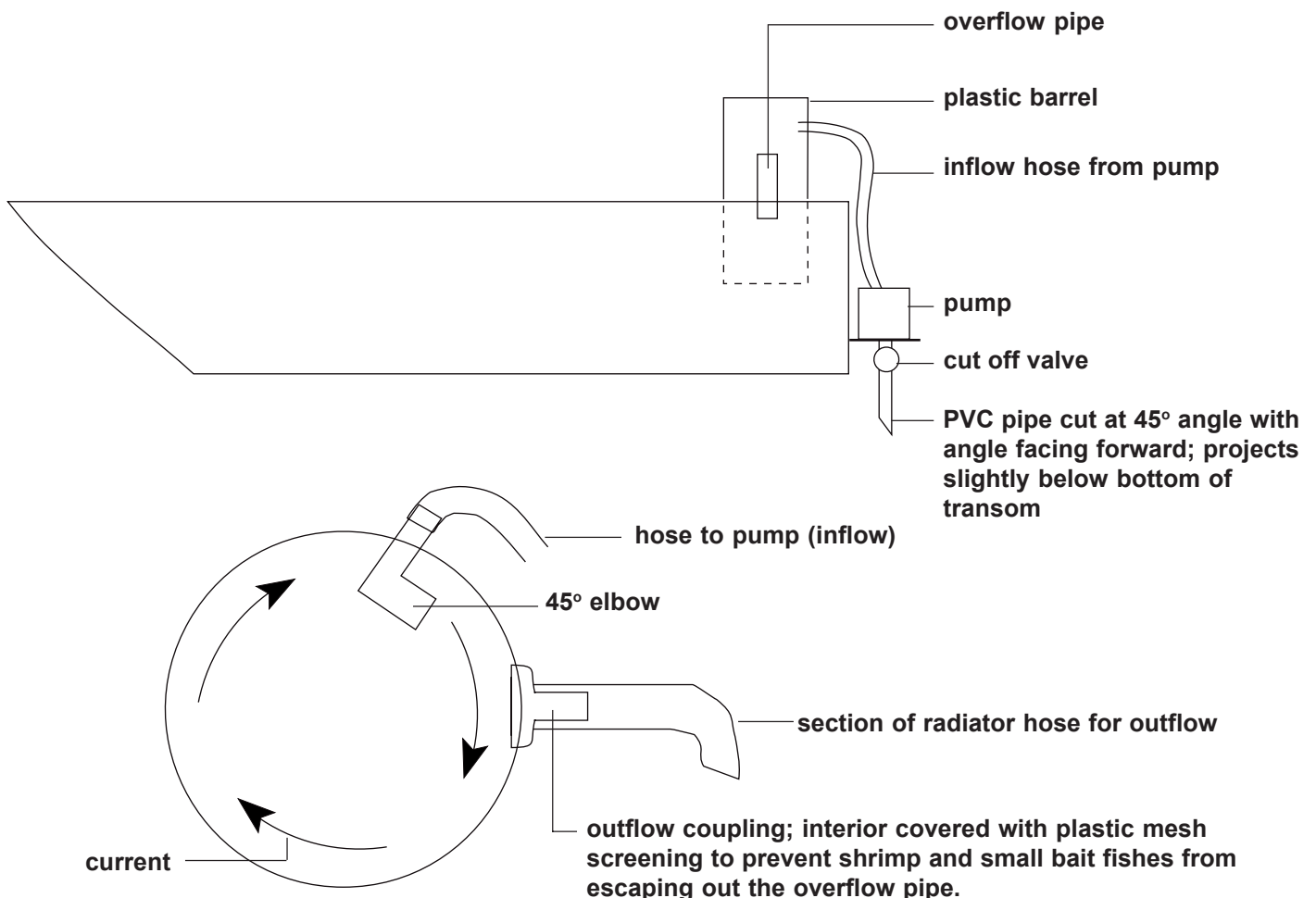
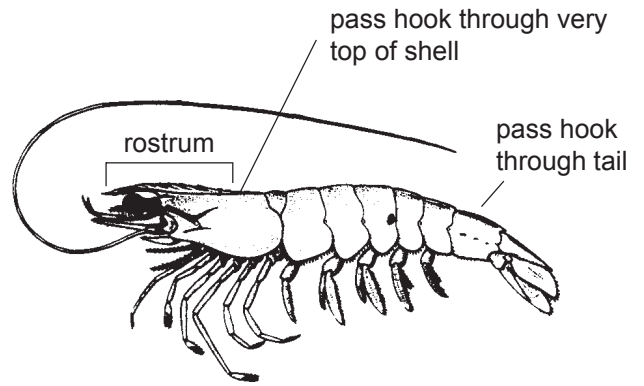

Figure 34. Continuous flow bait well setup.

menhaden fished on the bottom live bait rig (see Figure 33). When chasing big fish that may go 40 pounds, it is constructed of heavier materials such as a size #8 black brass barrel swivel, 50 pound test monofilament leader, and a 4/0 or 5/0 bronze short shank O'Shaughnessy hook. Around rocks like at the Charleston Harbor jetties, a 2 to 6 ounce egg sinker is used since currents are strong and the bait is large and active. With this terminal tackle, the bait will drift somewhat on the bottom, however, the round sinker does not hang up as frequently on irregular bottom as do other types of weights. On the sand bars and off the front beaches such as those around Bulls Bay, live bait can be fished on the fishfinder rig (see Figure 20) with a pyramid sinker of appropriate weight.

A question frequently posed by novice anglers concerns the best locations on the bait to secure it to a hook. Previously I mentioned that a main concern in the selection of the size and style of hook is to select one that allows the bait to swim as naturally as possible without fatally injuring it. Figure 35 shows the locations for hooking the four main live baits used along the South Carolina coast. Shrimp can be hooked just below the rostrum on the head or through the tail. When placing a shrimp on a hook by passing it through the body near the head region, be careful not to go down too far on the side and pass it through the shrimp's vital organs. To affix a mud minnow, pass the hook through both lips. One thing about mud minnows is that when they are fished on a shell covered bottom, the fish try to hide in the shells. This does two things. First, it takes the bait out of the view of the fish you're trying to catch, and second, it increases the chances of catching the bottom and losing your rig. Finger mullet can be attached through the top lip or by passing the hook through both eyes. Finally, my favorite bait, the menhaden can be attached by threading the hook through the bone near

Shrimp



Mudminnow

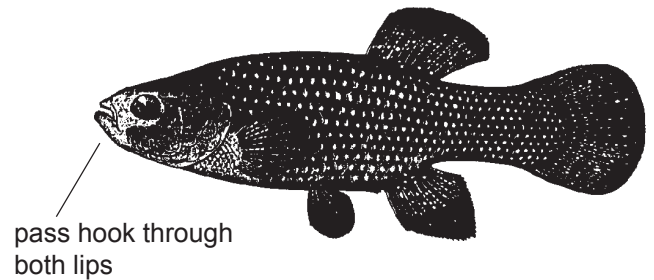

Finger mullet

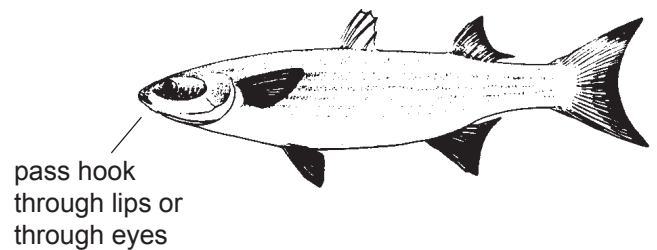

Menhaden

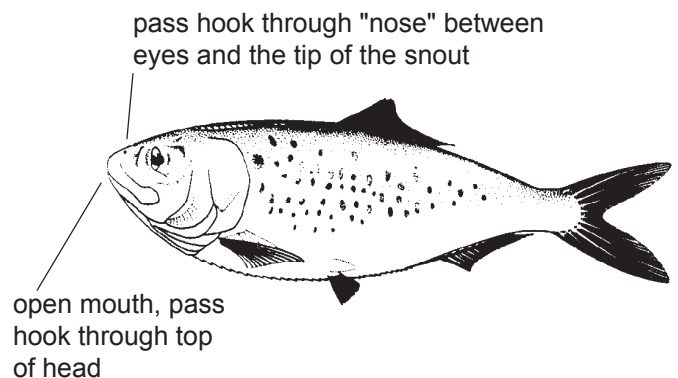

Figure 35. Locations for securing main live baits to hook.

the surface of the head in the area between the eyes and the tip of the snout, or by opening the mouth and passing the hook up through the top of the head in front of the eyes.

Although most red drum are taken on live or cut bait, artificial baits may induce strikes from this species. The most popular lure is the 1/4 ounce red grub head with a 4 inch long "Mister Twister" tail in either chartreuse green-metal flake or smoky-metal flake. Small bucktail jigs in yellow or white also take red drum. A trick I like to use is to dress the hooks of these jig type lure (grubs and bucktails) with a small piece of cut shrimp. This provides a natural scent that attracts feeding fish. Spoons such as the Krocodile (1/4 ounce, 2 1/8 inches long) or the Darderle (1/4 ounce, 1 3/4 inches long) in either brass or nickel colors are occasionally successful.

Plugs that I have taken some red drum with are the Rebel minnows such as the 4 1/2 inch long, 3/8 ounce or 5 1/2 inch long, 1/2 ounce floating minnow in silver/black and silver/blue colors, and the jointed minnows of the same lengths and colors. Generally, not many red drum are caught on plugs, but when you hang an eight pound fish on light tackle in 24 inches of water with a plug, it's an exciting experience.

When fishing a plug, spoon or grub I do not use any snaps or swivels. I tie the grub directly to the line with an improved clinch knot. Spoons and plugs are secured with a loop knot (Figure 36) which allows the bait a greater freedom of movement thereby giving it more action when pulled through the water. When you fish without a swivel, monofilament line will twist. The degree of twist depends upon the lure, with spoons twisting more than the other lures mentioned above. To remove twists, I cut the lure off and, while I am running the boat ahead, trail the monofilament line from the reel behind the boat. Simply free spool the amount you feel may be twisted, let it trail

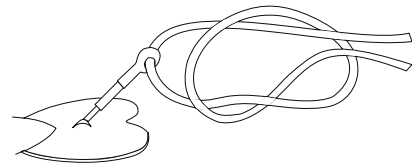

Fig. 1 Tie a simple Overhand Knot about 4 inches from the end of the line. Push the end of the line through the hook eye, then back through the center of the Overhand Knot.

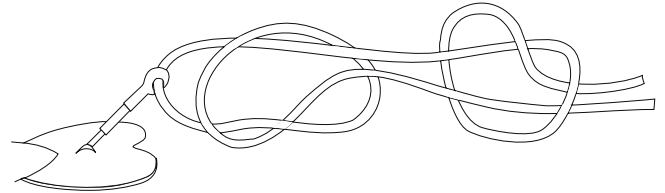

Fig. 2 Next, with the end of the line, make another Overhand Knot around the standing part of the line. Now slowly pull the two knots tight, at the same time sliding them together so they "jam" or lock against one another.

Figure 36. Loop knot for securing a plug or spoon to monofilament fishing line.

behind the moving boat for a few minutes, and reel it in. The twists will be gone.

RULES, REGULATIONS AND COMMENTS ON CONSERVATION

In South Carolina, red drum is classified as a gamefish and can not be bought or sold unless produced by a mariculture operation or is imported from a state that permits commercial harvesting (e.g., North Carolina). The source of all red drum sold commercially must be documented. Red drum can only be harvested with hook and line or gig. The gig season is closed, however, during December, January and February. The gig season is closed during these three months because red drum are less active then. Historically, large members of red drum would be giggered after a winter storm passed through the Low Country. The low temperatures and the strong northwest wind would rapidly cool the inshore waters. After the front passed, the winds diminished, and

the water regained clarity, spotted sea trout and red drum were easy targets for gigs because of their sluggish movement. The Exclusive Economic Zone (EEZ) of the United States which extends from the three mile limit to 200 miles offshore, is closed to the harvest of red drum. Red drum caught in these waters can not be retained.

In state waters, red drum smaller than 14 inches total length must be released. Total length is the straight line distance from the tip of the snout to the end of the tail. The possession limit is five red drum per angler per day of which only one can be larger than 32 inches total length.

The rationale for these regulations is derived from evidence that indicates that the number of red drum that escape harvest in the intense inshore fishery and survive long enough to reproduce is not adequate to insure a stable population for future generations. The five-fish bag limit is an attempt to restrict the harvest of the sub-adult red drum and thus insure that a portion of them reach the size and age at which they become mature, and then join the off-shore spawning population. The possession limit of one fish per angler per day for red drum greater than 32 inches total length is an attempt to protect the spawning fish that are found near inlets and along the ocean side of barrier islands. Almost all fish larger than 32 inches are mature, and this restriction reduces the fishing mortality on the reproductively active fishes. The ultimate goal of these regulations is to maintain the number of spawning fish at a level which will insure an adequate supply of juveniles and sub-adults inside our estuaries.

The above conservation measures are not readily accepted by some South Carolina anglers mainly because, historically recreational fishermen had few if any restrictions on their harvest. As a result, many anglers feel it is their God-given right to catch as many red drum or other fish as they want. Some of these anglers feel that the bounty of

the sea is endless. However, this has proven not to be the case. Abundances of many of the recreationally and commercially important species of marine fishes have declined to alarmingly low levels. The available information indicates that these declines have resulted from unrestricted levels of harvest. In the case of red drum in South Carolina, the recreational harvest alone has caused the problem since there is no commercial harvest in our state. Species like red drum that grow rapidly to an edible size (1 to 2 pounds in slightly more than a year) but mature slowly (do not reproduce for 3-5 years) are particularly vulnerable to over-harvesting.

We must remember that as members of a free and blessed society, it is a God-given right to fish. However, with every right comes a responsibility. Ours is to insure that our children and grandchildren have the opportunity to catch a red drum. This will not happen unless we do three things: 1) insure that adequate numbers of sub-adults escape to replace the spawning adults that die of natural causes; 2) protect spawning adults from excess harvest, and 3) protect the fragile juvenile nursery areas in the shallow marsh habitat. I hope that we can achieve these objectives. After spending the country into a massive debt, the least we can do is to leave future generations a few fish to catch.